

N-Channel MOSFET

1000V 4A TO-263

MFT100N4T263

MERITEK

FEATURE

- $R_{DS(ON)} < 3.8\Omega$ at $V_{GS}=10V, I_D=4A$
- High Power and Current Handling Capability
- Super High Dense Cell Design for Extremely Low $R_{DS(ON)}$

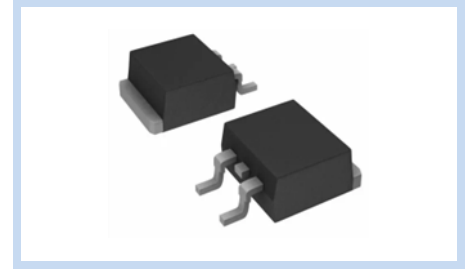

MECHANICAL DATA

- Case: TO-263 Package
- Terminals: Solderable per MIL-STD-750, Method 2026

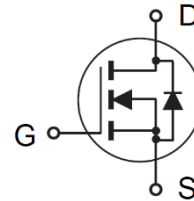

MAXIMUM RATINGS

Parameter		Symbol	Value	Unit
Drain-Source Voltage		V_{DS}	1000	V
Gate-Source Voltage		V_{GS}	± 30	V
Drain Current – Continuous	$T_C=25^\circ C$	I_D	4	A
Drain Current – Pulsed	$T_C=25^\circ C$	I_{DM}	16	A
Power Dissipation	$T_C=25^\circ C$	P_D	166	W
	Derate above $25^\circ C$		1.3	W
Thermal Resistance Junction to Ambient		$R_{\theta JA}$	62.5	$^\circ C/W$
Thermal Resistance Junction to Case		$R_{\theta JC}$	0.75	$^\circ C/W$
Operating Junction and Storage Temperature		T_J, T_{STG}	-55 to 150	$^\circ C$

DIMENSIONS

Item	Min. (mm)	Max. (mm)
A	4.29	4.70
A1	--	0.25
b	0.69	0.94
b2	1.22	1.40
c	0.36	0.56
c2	1.22	1.40
D	8.64	9.65
E	9.70	10.54
e	2.29	2.79
H	14.61	15.88
L	2.24	2.84
L1	--	1.40
L2	0.96	1.78

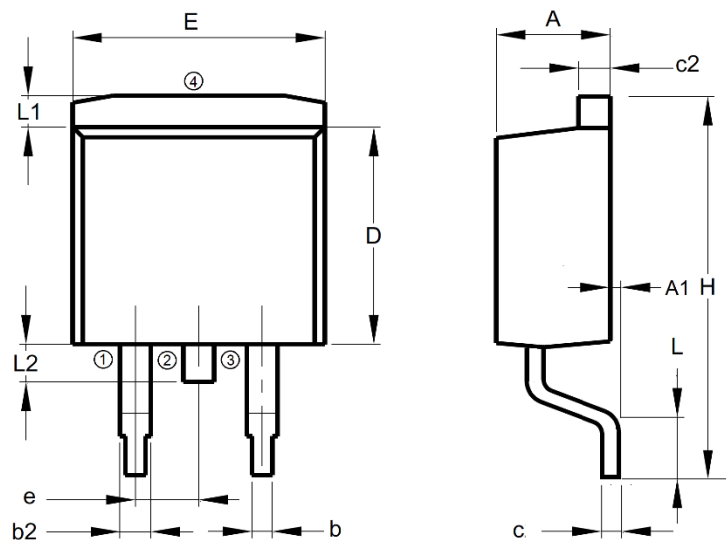

Note: 1: Gate, 2, 4: Drain, 3: Source

N-Channel MOSFET

1000V 4A TO-263

MFT100N4T263

MERITEK

ELECTRICAL CHARACTERISTICS

Off Characteristics	Conditions	Symbol	Min	Typ.	Max	Unit
Drain-Source Breakdown Voltage	$V_{GS}=0V, I_D=250\mu A$	BV_{DSS}	1000	--	--	V
Drain-Source Leakage Current	$V_{DS}=1000V, V_{GS}=0V$	I_{DSS}	--	--	1	μA
Gate-Body Leakage Current, Forward	$V_{GS}=30V, V_{DS}=0V$	I_{GSSF}	--	--	100	nA
Gate-Body Leakage Current, Reverse	$V_{GS}=-30V, V_{DS}=0V$	I_{GSSR}	--	--	-100	
On Characteristics	Conditions	Symbol	Min	Typ.	Max	Unit
Static Drain-Source On-Resistance	$V_{GS}=10V, I_D=4A$	$R_{DS(ON)}$	--	3	3.8	Ω
Gate Threshold Voltage	$V_{GS}=V_{DS}, I_D=250\mu A$	$V_{GS(th)}$	2	--	4	V
Dynamic Characteristics	Conditions	Symbol	Min	Typ.	Max	Unit
Total Gate Charge	$V_{DS}=480V, V_{GS}=10V, I_D=4A$	Q_g	--	27	--	nC
Gate-Source Charge		Q_{gs}	--	7	--	
Gate-Drain Charge		Q_{gd}	--	7	--	
Turn-On Delay Time	$V_{DD}=300V, V_{GS}=10V, R_G=25\Omega, I_D=4A$	$T_{d(on)}$	--	33	--	ns
Rise Time		T_r	--	17	--	
Turn-Off Delay Time		$T_{d(off)}$	--	82	--	
Fall Time		T_f	--	25	--	
Input Capacitance	$V_{DS}=25V, V_{GS}=0V, F=1MHz$	C_{iss}	--	1390	--	pF
Output Capacitance		C_{oss}	--	115	--	
Reverse Transfer Capacitance		C_{rss}	--	15	--	
Drain-Source Body Diode	Conditions	Symbol	Min	Typ.	Max	Unit
Drain-Source Diode Forward Current	--	I_S	--	--	4	A
Diode Forward Voltage	$V_{GS}=0V, I_S=4A, T_J=25^\circ C$	V_{SD}	--	--	1.4	V

Note:

1. Repetitive Rating: Pulse width limited by maximum junction temperature.
2. Pulse Test: Pulse Width $\leq 300\mu s$, Duty Cycle $\leq 2\%$
3. Guaranteed by design, not subject to production testing.
4. Limited only by maximum temperature allowed.
5. Pulse Width Limited by safe operating area.
6. Full Package $I_{S(MAX)}=2.2A$
7. Full Package V_{SD} test condition $I_S = 2.2A$

Switching Time Waveform

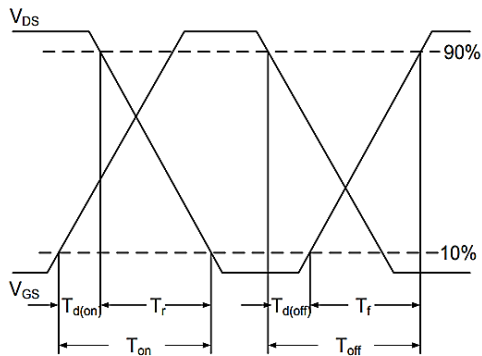

Switching Test Circuit

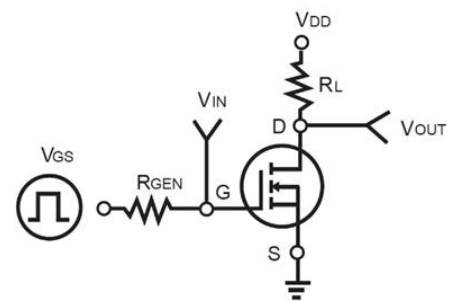

N-Channel MOSFET

1000V 4A TO-263

MFT100N4T263

MERITEK

CHARACTERISTIC CURVES

Output Characteristics

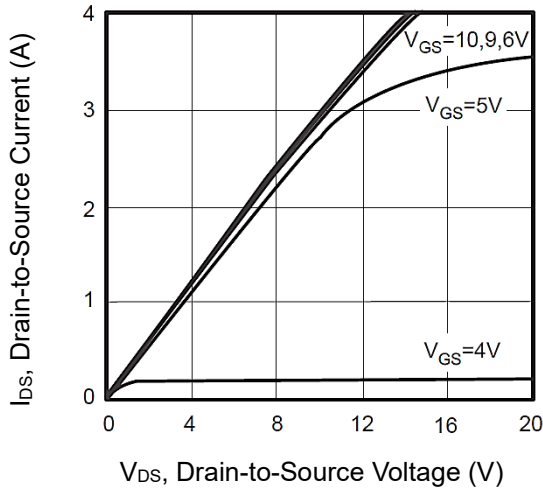

Transfer Characteristics

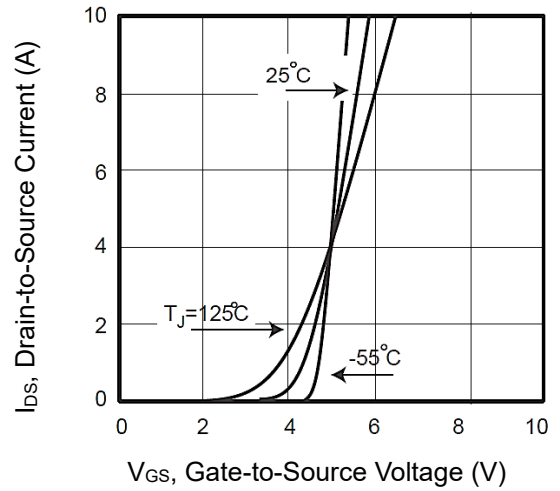

Breakdown Voltage vs. Temperature

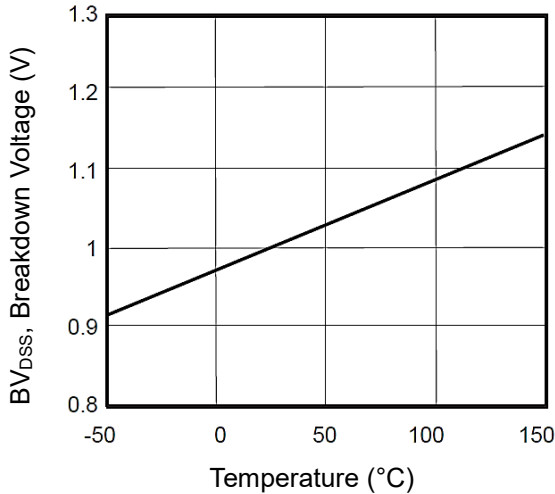

On-Resistance vs. Junction temperature

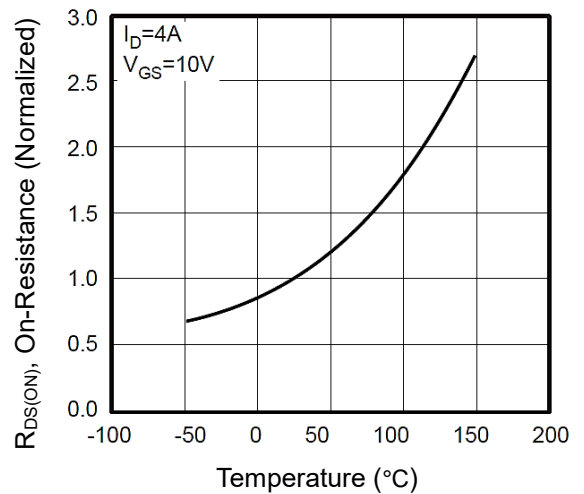

Threshold Voltage Variation with Temperature

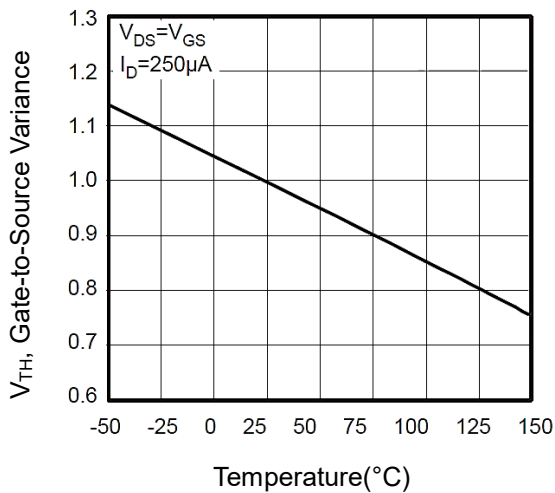

Body Diode Characteristics

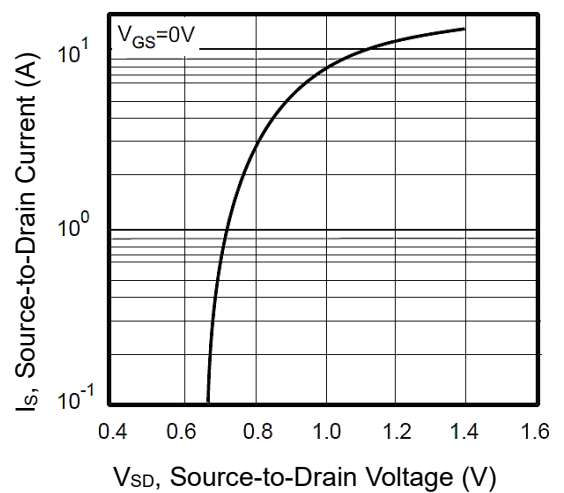

N-Channel MOSFET

1000V 4A TO-263

MFT100N4T263

MERITEK

CHARACTERISTIC CURVES

Gate-Charge Characteristics

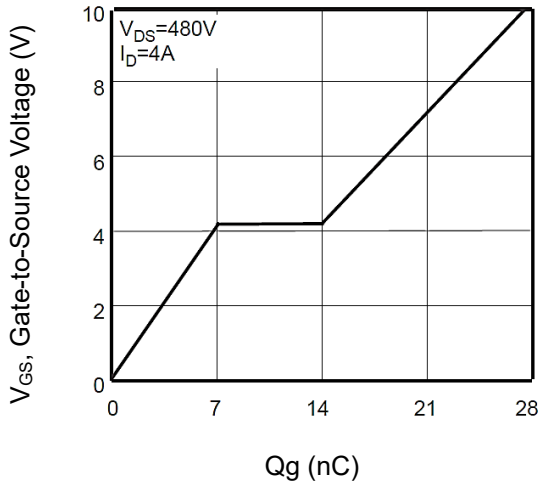

Capacitance vs. Drain-Source Voltage

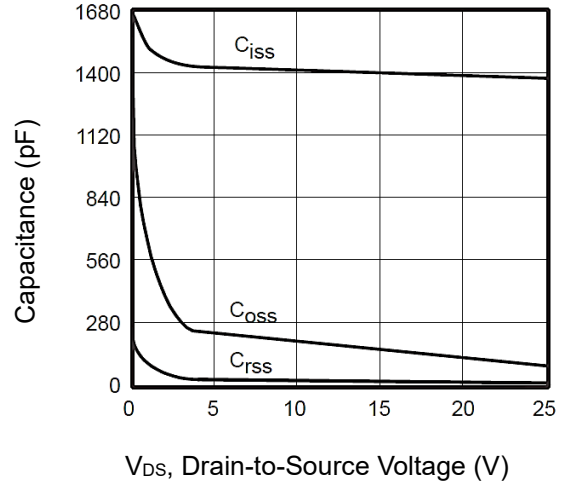

Maximum Safe Operating Area

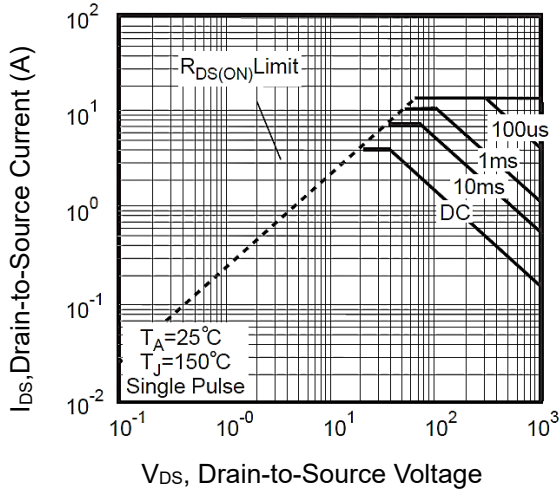

Normalized Transient Thermal Impedance vs Pulse Width

