

Chip Ferrite Bead High Current AEC-Q200 Type

SIM82-M32 series

MERITEK

FEATURE

- Operating temperature: -55°C ~ +150°C (Including self-temperature rise)
- Monolithic inorganic material construction.
- Closed magnetic circuit avoids crosstalk.
- Excellent solderability and heat resistance
- High reliability
- Low DC resistance electrode structure
- AEC-Q200 Compliant



PART NUMBERING SYSTEM



SIM 82 800 Y 6A0 M32
(1) (2) (3) (4) (5) (6)

No	item	Code	Description	
(1)	Product Code	SIM	Signal Chip Inductor, Multi-Layer Chip Ferrite Bead Type	
(2)	Dimension	82	82: 1812, 4.5x3.2mm	See Dimension Table
(3)	Impedence	800	800: 80Ω	First two: Significant, Third: Multiplier
(4)	Tolerance	Y	Y: ±25%	-25% ~ +25%
(5)	Rated Current	6A0	6A0: 6.0A	Max Current, 'A' denotes decimal point
(6)	Series Code	M32	Chip Ferrite Bead, High Current AEC-Q200	Internal Control Code

DIMENSIONS

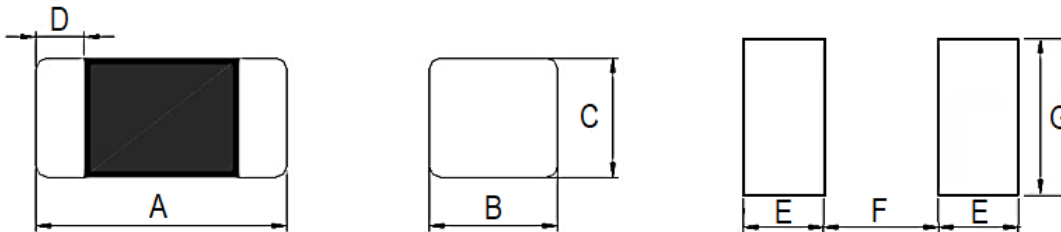

Size Code	A (mm)	B (mm)	C (mm)	D (mm)	E (mm)	F (mm)	G (mm)
SIM02 (0402)	1.00±0.10	0.50±0.10	0.50±0.10	0.25±0.10	0.50	0.40	0.60
SIM03 (0603)	1.60±0.15	0.80±0.15	0.80±0.15	0.30±0.20	0.80	0.85	0.95
SIM05 (0805)	2.00±0.20	1.25±0.20	0.85±0.20	0.50±0.30	1.05	1.00	1.45
SIM06 (1206)	3.20±0.20	1.60±0.20	1.10±0.20	0.50±0.30	1.05	2.20	1.80
SIM86 (1806)	4.50±0.20	1.60±0.20	1.60±0.20	0.50±0.30	1.05	3.30	1.80
SIM82 (1812)	4.50±0.20	3.20±0.20	1.50±0.20	0.50±0.30	1.05	3.30	3.40

Chip Ferrite Bead High Current AEC-Q200 Type

SIM82-M32 series

MERITEK

ELECTRICAL CHARACTERISTICS

Size	Part Number	Impedance (Ω)	Tolerance (%)	Test Frequency (MHz)	DCR (Ω) Max.	Rated Current (mA)
1812	SIM82800Y6A0M32	80	± 25	100	0.01	6000
	SIM82151Y5A0M32	150	± 25	100	0.02	5000
	SIM82681Y4A0M32	680	± 25	100	0.03	4000
	SIM82132Y3A0M32	1300	± 25	100	0.06	3000

CHARACTERISTIC CURVES

SIM82800Y6A0M32

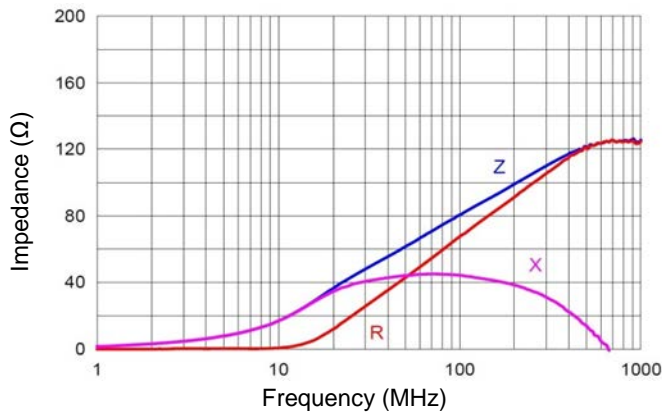

SIM82151Y5A0M32

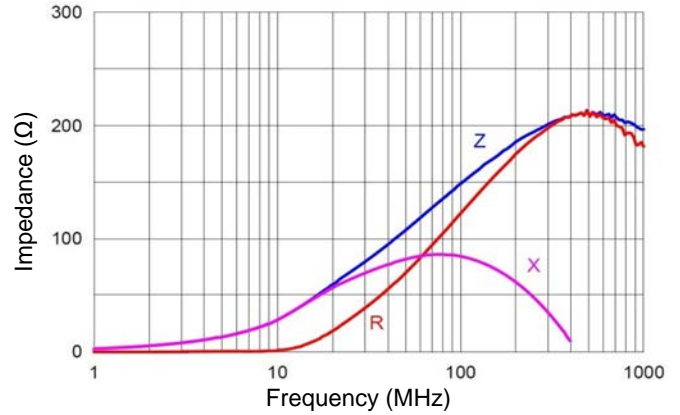

SIM82681Y4A0M32

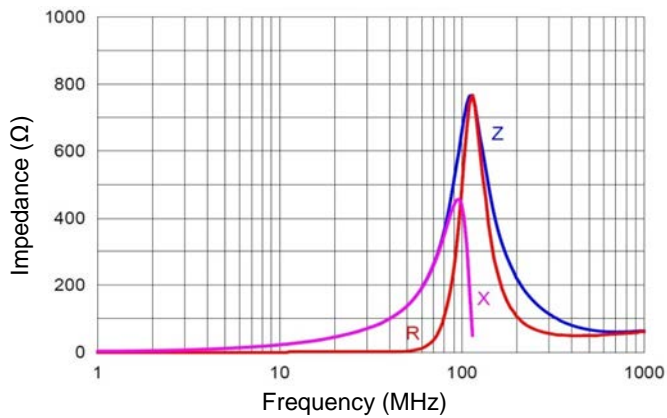

SIM82132Y3A0M32

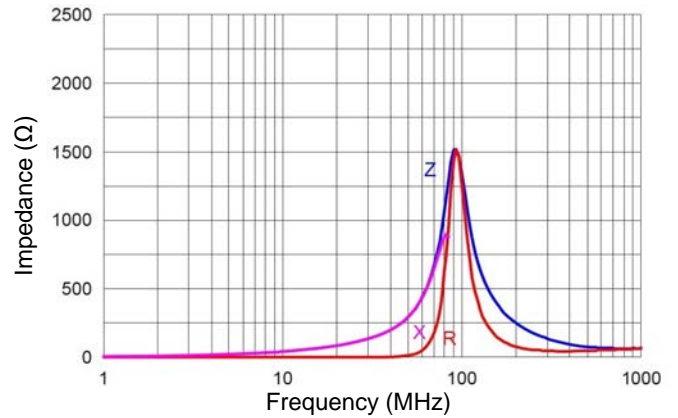

Chip Ferrite Bead High Current AEC-Q200 Type

SIM82-M32 series

MERITEK

RELIABILITY TEST CONDITON AND REQUIREMENT

Item	Test Conditions	Requirement															
Temperature Rise Test	Applied the allowed DC current. Temperature measured by digital surface thermometer.	Rated Current < 1A ΔT 20°CMax. Rated Current \geq 1A ΔT 40°CMax.															
High Temperature Exposure (Storage)	Preconditioning: Run through IR reflow for 3 times. Temperature: 150 \pm 2°C Duration: 1000hrs Min. Measured at room temperature after 24 \pm 2 Hrs.	Appearance: no damage. Impedance: within \pm 15%of initial value. Inductance: within \pm 10%of initial value. Q: shall not exceed the specification value. RDC: within \pm 15% of initial value and shall not exceed the specification value.															
Temperature Cycling	Preconditioning: Run through IR reflow for 3 times. Number of cycles: 1000. Condition for 1 cycle: <table border="1" data-bbox="332 709 982 865"> <thead> <tr> <th>No.</th> <th>Temp. (°C)</th> <th>Time (min.)</th> </tr> </thead> <tbody> <tr> <td>1</td> <td>-55\pm2°C</td> <td>30 Min.</td> </tr> <tr> <td>2</td> <td>+150\pm2°C Transition time</td> <td>1 Max.</td> </tr> <tr> <td>3</td> <td>+150\pm2°C</td> <td>30 Min.</td> </tr> <tr> <td>4</td> <td>Low Temperature Transition time</td> <td>1 Max.</td> </tr> </tbody> </table> Measured at room temperature after placing for 24 \pm 2 hrs.	No.	Temp. (°C)	Time (min.)	1	-55 \pm 2°C	30 Min.	2	+150 \pm 2°C Transition time	1 Max.	3	+150 \pm 2°C	30 Min.	4	Low Temperature Transition time	1 Max.	Appearance: no damage. Impedance: within \pm 15%of initial value. Inductance: within \pm 10%of initial value. Q: shall not exceed the specification value. RDC: within \pm 15% of initial value and shall not exceed the specification value.
No.	Temp. (°C)	Time (min.)															
1	-55 \pm 2°C	30 Min.															
2	+150 \pm 2°C Transition time	1 Max.															
3	+150 \pm 2°C	30 Min.															
4	Low Temperature Transition time	1 Max.															
Biased Humidity (AEC-Q200)	Preconditioning: Run through IR reflow for 3 times. Humidity: 85 \pm 3%R.H. Temperature: 85 \pm 2°C. Duration: 1000hrs Min. with 100% rated current. Measured at room temperature after 24 \pm 2 hrs.	Appearance: no damage. Impedance: within \pm 15%of initial value. Inductance: within \pm 10%of initial value. Q: shall not exceed the specification value. RDC: within \pm 15% of initial value and shall not exceed the specification value.															
High Temperature Operational Life	Preconditioning: Run through IR reflow for 3 times. Temperature: 150 \pm 2°C Duration: 1000hrs Min. with 100% rated current. Measured at room temperature after 24 \pm 2 Hrs.	Appearance: no damage. Impedance: within \pm 15%of initial value. Inductance: within \pm 10%of initial value. Q: shall not exceed the specification value. RDC: within \pm 15% of initial value and shall not exceed the specification value.															
External Visual	Inspect device construction, marking and workmanship. Electrical test not required	Appearance: no damage.															
Physical Dimension	According to the product specification size measurement	According to the product specification size measurement															
Resistance to Solvents	Add aqueous wash chemical – OKEM clean or equivalent	Appearance: no damage.															
Mechanical Shock	Preconditioning: Run through IR reflow for 2 times. Test condition: <table border="1" data-bbox="332 1654 982 1795"> <thead> <tr> <th>Type</th> <th>Peak Value (g's)</th> <th>Normal duration (ms)</th> <th>Wave Form</th> <th>Velocity change (ft/sec)</th> </tr> </thead> <tbody> <tr> <td>SMD</td> <td>100</td> <td>6</td> <td>Half-sine</td> <td>12.3</td> </tr> <tr> <td>Lead</td> <td>100</td> <td>6</td> <td>Half-sine</td> <td>12.3</td> </tr> </tbody> </table> 3 shocks in each direction along 3 perpendicular axes.	Type	Peak Value (g's)	Normal duration (ms)	Wave Form	Velocity change (ft/sec)	SMD	100	6	Half-sine	12.3	Lead	100	6	Half-sine	12.3	Appearance: no damage. Impedance: within \pm 15%of initial value. Inductance: within \pm 10%of initial value. Q: shall not exceed the specification value. RDC: within \pm 15% of initial value and shall not exceed the specification value.
Type	Peak Value (g's)	Normal duration (ms)	Wave Form	Velocity change (ft/sec)													
SMD	100	6	Half-sine	12.3													
Lead	100	6	Half-sine	12.3													

Chip Ferrite Bead High Current AEC-Q200 Type

SIM82-M32 series

MERITEK

RELIABILITY TEST CONDITION AND REQUIREMENT

Item	Test Conditions	Requirement												
Vibration	Preconditioning: Run through IR reflow for 3 times. Oscillation Frequency: 10~2K~10 Hz for 20 minutes Equipment: Vibration checker Total Amplitude:10g Testing Time: 12 hours (20 minutes, 12 cycles each of 3 orientations)	Appearance: no damage. Impedance: within±15%of initial value. Inductance: within±10%of initial value. Q: Shall not exceed the specification value RDC: within ±15% of initial value and shall not exceed the specification value.												
Resistance to Soldering Heat	Test Condition: MIL-STD-202 Condition B Number of heat cycles: 1, Depth: Completely cover the termination Temperature: 260±5°C for 10 sec. Temperature ramp/immersion and emersion rate 25mm/s ±6 mm/s.	Appearance: no damage. Impedance: within±15%of initial value. Inductance: within±10%of initial value. Q: Shall not exceed the specification value RDC: within ±15% of initial value and shall not exceed the specification value.												
Thermal Shock	Preconditioning: Run through IR reflow for 3 times. Number of cycles: 300. Condition for 1 cycle: <table border="1" data-bbox="334 842 982 961"> <thead> <tr> <th>No.</th> <th>Temp. (°C)</th> <th>Time (min.)</th> </tr> </thead> <tbody> <tr> <td>1</td> <td>-55±2°C</td> <td>15±1</td> </tr> <tr> <td>2</td> <td>+150±2°C</td> <td>within 20 sec.</td> </tr> <tr> <td>3</td> <td>+150±2°C</td> <td>15±1</td> </tr> </tbody> </table> Measured at room temperature after placing for 24±2 hrs.	No.	Temp. (°C)	Time (min.)	1	-55±2°C	15±1	2	+150±2°C	within 20 sec.	3	+150±2°C	15±1	Appearance: no damage. Impedance: within±15%of initial value. Inductance: within±10%of initial value. Q: shall not exceed the specification value. RDC: within ±15% of initial value and shall not exceed the specification value.
No.	Temp. (°C)	Time (min.)												
1	-55±2°C	15±1												
2	+150±2°C	within 20 sec.												
3	+150±2°C	15±1												
ESD	Direct contact discharge 4KV (Level 2)	Appearance: no damage.												
Solderability	Method B, 4hrs at 155°C, dry heat at 235°C±5°C, Test time: 5 +0/-0.5 sec. Method D category 3. (Steam aging 8 hrs ±15min) at 260°C±5°C, Test time: 30 +0/-0.5 sec.	More than 95% of the terminal electrode should be covered with solder.												
Flammability	V-0 or V-1 are acceptable	Electrical test not required.												
Bending	Shall be mounted on a FR4 substrate of the following dimensions: <table border="1" data-bbox="334 1409 982 1470"> <thead> <tr> <th>Dimensions</th> <th>Bending depth</th> </tr> </thead> <tbody> <tr> <td>40x100x1.6mm</td> <td>2.0mm (min).</td> </tr> </tbody> </table> Duration of applied force 60+5 sec. The force is to be applied only once to the board	Dimensions	Bending depth	40x100x1.6mm	2.0mm (min).	Appearance: no damage.								
Dimensions	Bending depth													
40x100x1.6mm	2.0mm (min).													
Terminal strength	Preconditioning: Run through IR reflow for 2 times. With component mounted on a PCB apply a force of 17.7(N) (1.8Kg) force to the side of a device being tested. This force shall be applied for 60 +1 seconds. Also, the force shall be applied gradually as not to shock the component being tested.	Appearance: no damage.												

Chip Ferrite Bead High Current AEC-Q200 Type

SIM82-M32 series

MERITEK

RECOMMENDED SOLDERING PROFILES

Reflow Condition		
Pre Heat	Temp. Min $T_{s(min)}$	150°C
	Temp. Max $T_{s(max)}$	200°C
	Time (min. to max.) (t_s)	60 ~120 seconds
Reflow	Temp. (T_L)	217°C
	Time (min. to max.) (t_L)	60 ~150 seconds
Peak Temperature (T_P)		260°C
Time within 5°C of actual peak Temperature (t_p)		< 30 seconds
Reflow times:		3 times Max.

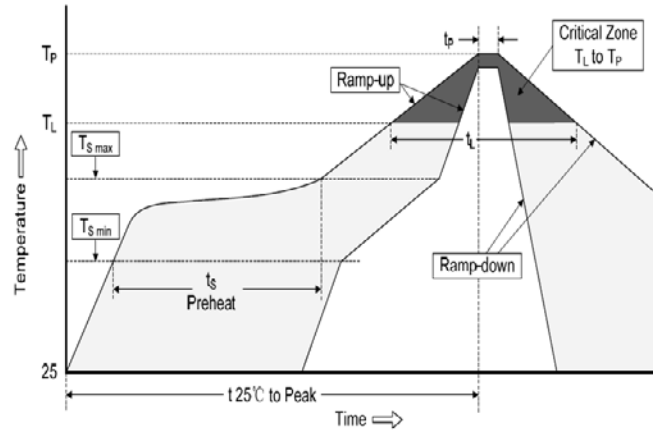

DERATING CURVE

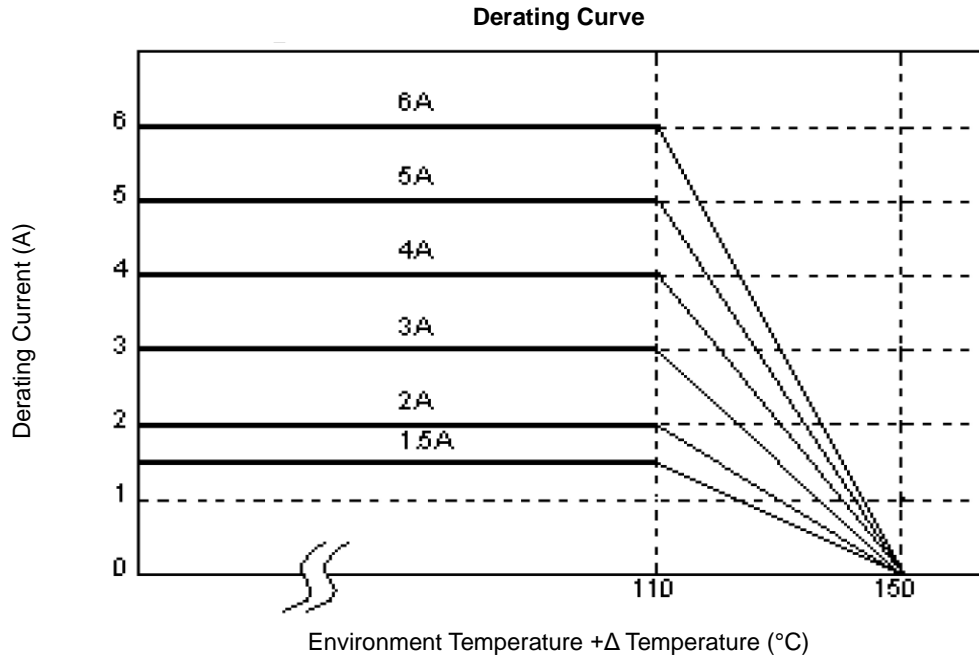

Chip Ferrite Bead High Current AEC-Q200 Type

SIM82-M32 series

MERITEK

PACKAGING SPECIFICATIONS

Reel Specification & Packaging Quantity

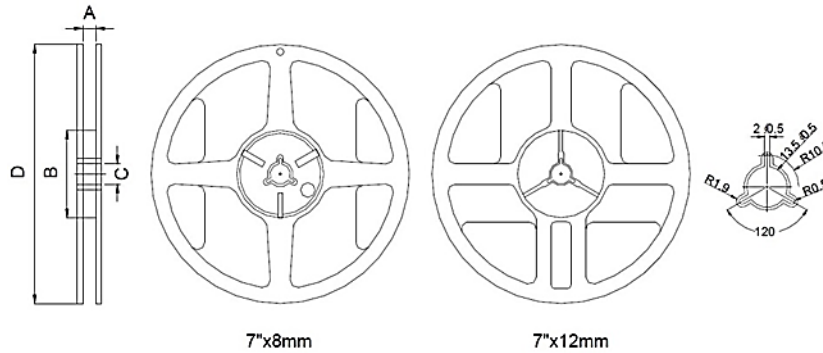

Size	Reel Dimension (mm)						
	Quantity	Tape Width	Reel Diameter	A	B	C	D
0402	Paper 10K	8mm	7"	9.5±0.5	60.0±2.0	13.5±0.5	178.0±2.0
0603	Paper 4K	8mm	7"	9.5±0.5	60.0±2.0	13.5±0.5	178.0±2.0
0805	Paper 4K	8mm	7"	9.5±0.5	60.0±2.0	13.5±0.5	178.0±2.0
1206	Plastic 3K	8mm	7"	9.5±0.5	60.0±2.0	13.5±0.5	178.0±2.0
1806	Plastic 2K	12mm	7"	13.5±0.5	60.0±2.0	13.5±0.5	178.0±2.0
1812	Plastic 1K	12mm	7"	13.5±0.5	60.0±2.0	13.5±0.5	178.0±2.0

PACKAGING SPECIFICATIONS

Paper Tape Specification

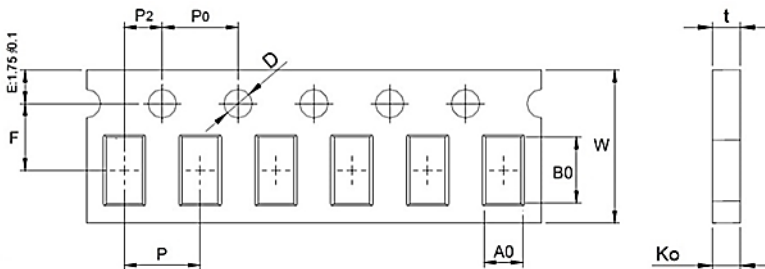

Plastic Tape Specification

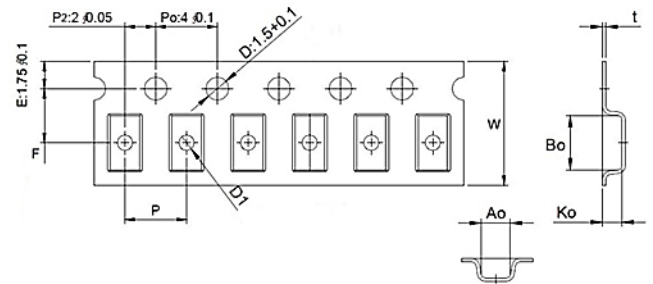

Size	Paper Tape Dimension (mm)									
	A0	B0	W	F	P ₀	P	P ₂	D	t	Ko
0402	0.62±0.03	1.12±0.03	8±0.3	3.5±0.05	4±0.1	2±0.05	-	1.5±0.1	0.6±0.03	0.6±0.03
0603	0.96±0.05/-0.03	1.80±0.05	8±0.1	3.5±0.1	4±0.1	4±0.1	2±0.1	1.56±0.1/-0.05	0.95±0.05	0.95±0.05
0805	1.3±0.05	2.1±0.05	8±0.1	3.5±0.1	4±0.1	4±0.1	2±0.1	1.56±0.1/-0.05	0.95±0.05	0.95±0.05
Size	Plastic Tape Dimension (mm)									
	A0	B0	W	F	P	P ₀	P ₂	D1	t	Ko
1206	1.75±0.1	3.35±0.1	8±0.1	3.5±0.05	4±0.1	4±0.1	2±0.05	1±0.1	0.23±0.05	1.25±0.1
1806	1.75±0.1	4.7±0.1	12±0.1	5.5±0.05	4±0.1	4±0.1	2±0.05	1.5±0.1	0.24±0.05	1.75±0.1
1812	3.45±0.1	4.7±0.1	12±0.1	5.5±0.05	8±0.1	4±0.1	2±0.05	1.5±0.1	0.24±0.05	1.60±0.1

*Specifications subject to change without notice.