

ESD Suppressor 8V 2-Unidirectional SOT-23

ME82U13V4S23

MERITEK

FEATURE

- IEC 61000-4-2 ESD: $\pm 30\text{KV}$ (Air) $\pm 30\text{KV}$ (Contact)
- ESD Protection for two Unidirectional Channels
- ESD Protection for one Bidirectional Channel
- Low Clamping Voltage

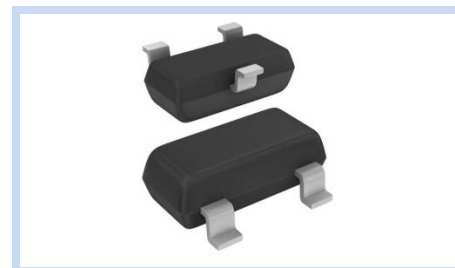

APPLICATION

- Industrial Controls
- Set-Top Box
- Portable Devices
- Notebooks, PC Desktops and Servers

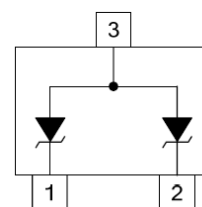

MAXIMUM RATINGS AND CHARACTERISTICS

Parameter	Symbol	Value	Unit
ESD Voltage (Contact discharge)	V_{ESD}	± 30	KV
ESD Voltage (Air discharge)		± 30	
Peak Pulse Power ($t_p=8/20\mu s$)	P_{PP}	500	W
Peak Pulse Current ($t_p=8/20\mu s$)	I_{PP}	34	A
Operating & Storage Temperature Range	T_J, T_{STG}	-50~+150	$^{\circ}\text{C}$

ELECTRICAL CHARACTERISTICS

Parameter	Condition	Symbol	Min.	Typ.	Max.	Unit
Reverse Stand-Off Voltage	--	V_{RWM}	--	--	8	V
Reverse Breakdown Voltage	$I_{BR}=1\text{mA}$	V_{BR}	8.5	--	--	V
Reverse Leakage Current	$V_{RWM}=8\text{V}$	I_R	--	--	10	μA
Forward Voltage	$I_F=100\text{mA}$, 300 μs -square wave	V_F	--	--	1.5	V
Clamping Voltage	$I_{PP}=34\text{A}$, $t_p=8/20\mu s$	V_C	--	--	13.4	V
Off State Junction Capacitance	$V_{dc}=0$, $f=1\text{MHz}$, Between I/O pins and GND	C_J	--	--	250	pF

Notes:

1. $T_A=25^{\circ}\text{C}$ unless otherwise specified

ESD Suppressor 8V 2-Unidirectional SOT-23

ME82U13V4S23

MERITEK

CHARACTERISTIC CURVES

Pulse Waveform

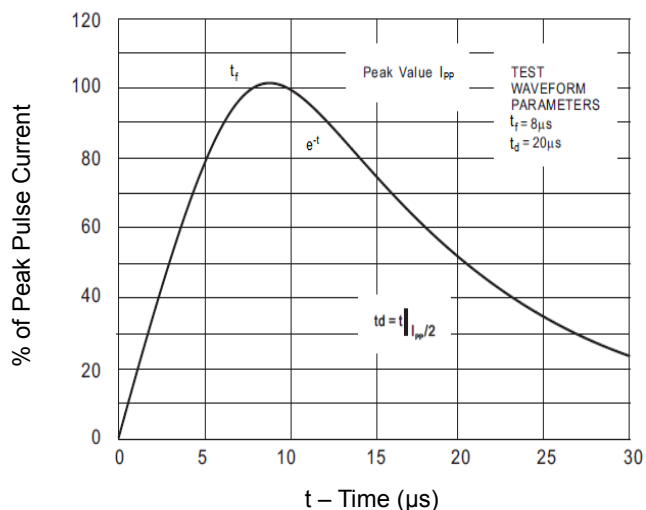

Power Derating Curve

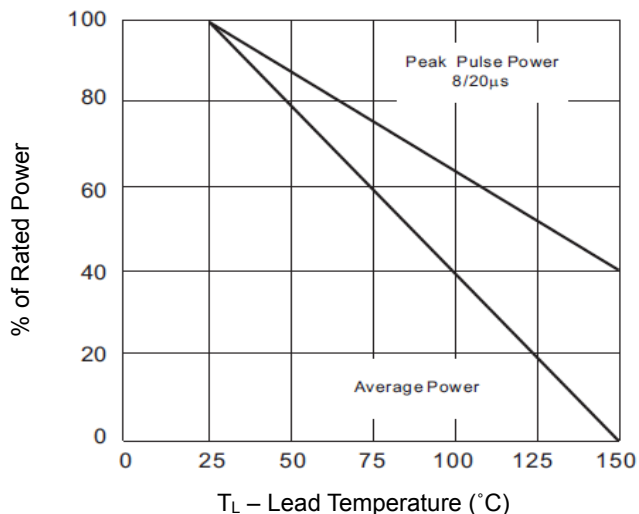

Peak Pulse Power vs. Pulse Time

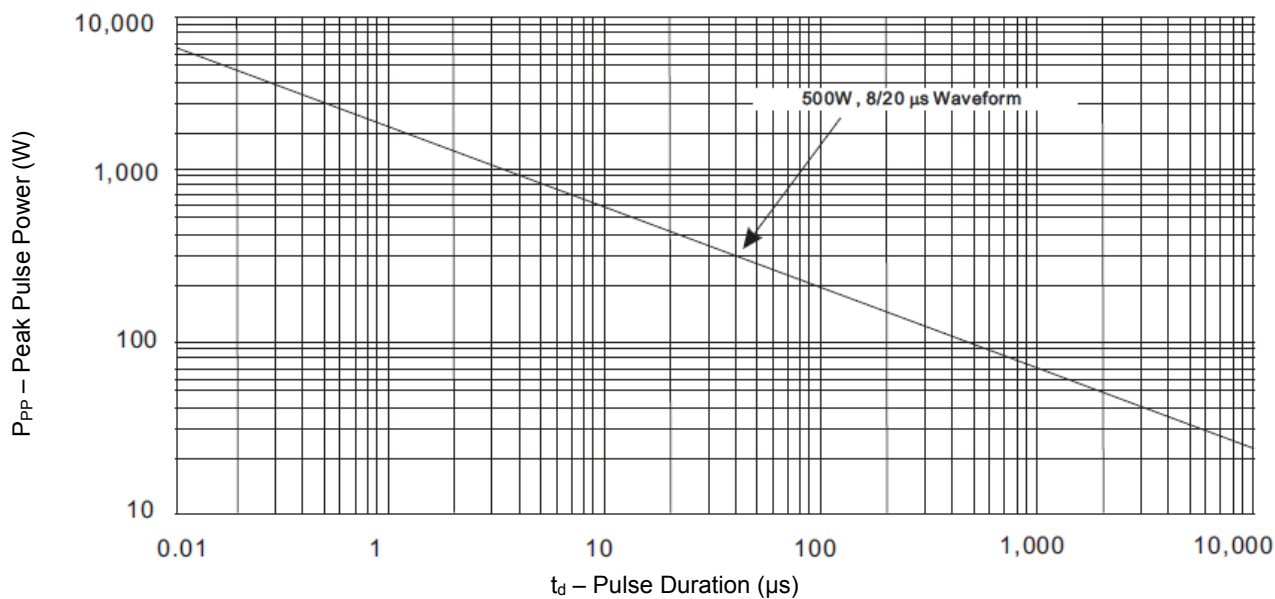

ESD Suppressor 8V 2-Unidirectional SOT-23

ME82U13V4S23

MERITEK

DIMENSIONS AND RECOMMENDED LAND PATTERN

Item	Min (mm)	Max (mm)
A1	0.08	0.20
A2	0.82	0.90
b	0.35	0.50
C	0.00	0.10
D	2.80	3.04
e	--	--
e1	1.80	2.00
E	2.20	2.60
E1	1.20	1.40
L	0.15	--
X	0.80	0.80
X1	1.35	1.35
Y	2.90	2.90
Y1	0.90	0.90
Y2	2.00	2.00

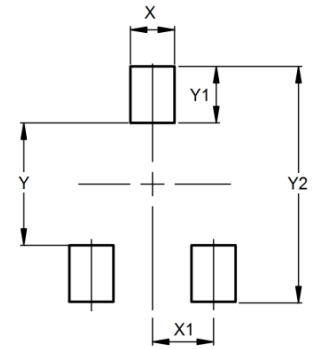
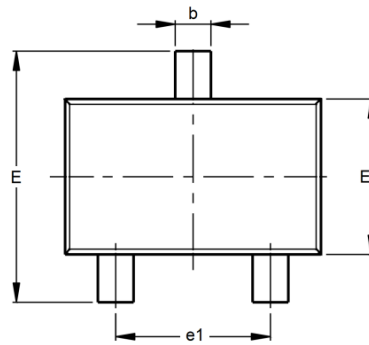
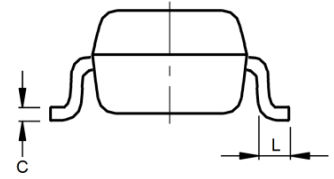
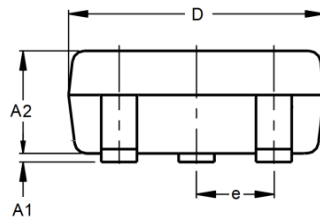

*Specifications subject to change without notice.