

ESD Suppressor 70V 4-Unidirectional SOT-23-6

ME704U85RS236

MERITEK

FEATURE

- IEC 61000-4-2 ESD: $\pm 15\text{KV}$ (Air) $\pm 8\text{KV}$ (Contact)
- ESD Protection for four Unidirectional Channels
- Low Leakage Current
- Solid-State Silicon-Avalanche Technology

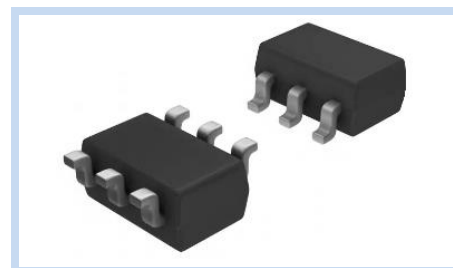

APPLICATION

- USB Power and Data Line Protection
- LAN/WLAN Device
- Video Line Protection
- Microcontroller Input Protection
- Handheld Electronics

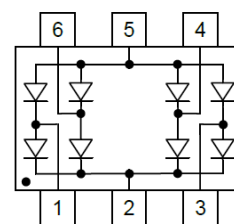

MAXIMUM RATINGS AND CHARACTERISTICS

Parameter	Symbol	Value	Unit
ESD Voltage (Contact discharge)	V_{ESD}	>8	KV
ESD Voltage (Air discharge)		>15	
Operating & Storage Temperature Range	T_J, T_{STG}	-55~+150	$^{\circ}\text{C}$

ELECTRICAL CHARACTERISTICS

Parameter	Condition	Symbol	Min.	Typ.	Max.	Unit
Reverse Stand-Off Voltage	--	V_{RRM}	--	--	70	V
Reverse Breakdown Voltage	$I_{\text{BR}}=50\mu\text{A}$	V_{BR}	85	--	--	V
Reverse Leakage Current	$V_{\text{RWM}}=70\text{V}$	I_{R}	--	0.1	1	μA
Surge Non-Repetitive Forward Current	$t_p=2.5\mu\text{s}$, Rectangular Wave	I_{FSM}	--	--	6	A
	$t_p=1\text{ms}$, Rectangular Wave		--	--	2	
	$t_p=100\text{ms}$, Rectangular Wave		--	--	1	
Off State Junction Capacitance	$V_{\text{dc}}=0$, $f=1\text{MHz}$, Between I/O pins and GND	C_J	--	--	1	pF
	$V_{\text{dc}}=0$, $f=1\text{MHz}$, Between I/O pins		--	--	0.9	

Notes:

1. $T_J=25^{\circ}\text{C}$ unless otherwise specified

ESD Suppressor 70V 4-Unidirectional SOT-23-6

ME704U85RS236

MERITEK

CHARACTERISTIC CURVES

Forward Characteristics

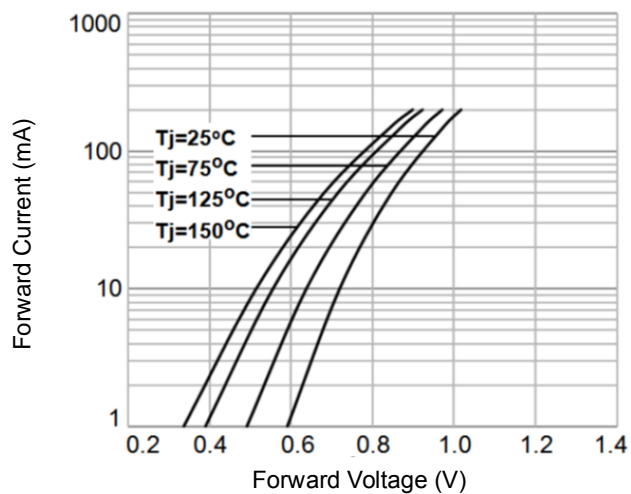

Reverse Characteristics

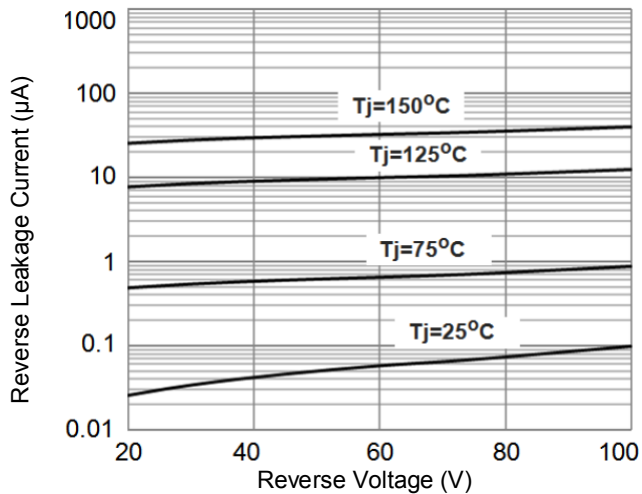

Capacitance vs. Reverse Voltage

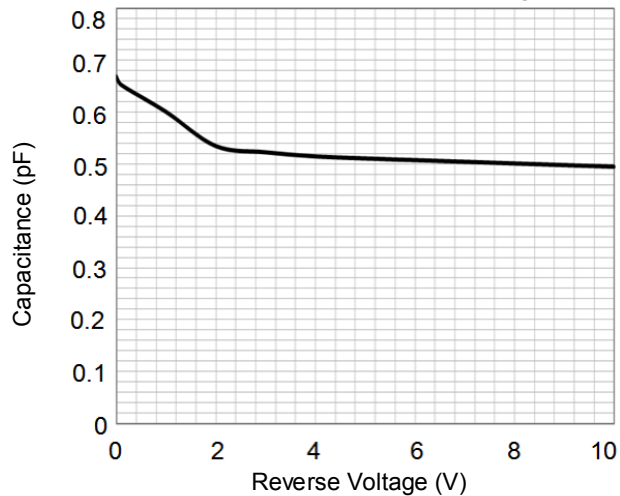

ESD Suppressor 70V 4-Unidirectional SOT-23-6

ME704U85RS236

MERITEK

DIMENSIONS AND RECOMMENDED LAND PATTERN

Item	Min (mm)	Max (mm)
A1	0.00	0.15
A2	1.30	0.90
A3	0.00	1.45
b	0.30	0.50
C	0.08	0.22
D	2.80	3.00
e	0.00	0.95
e1	0.00	1.90
E	2.60	3.00
E1	1.50	1.70
L	0.30	0.60
Y	1.60	1.60
Y1	0.79	0.79
Y2	3.10	3.10
X	0.55	0.55
X1	0.94	0.94

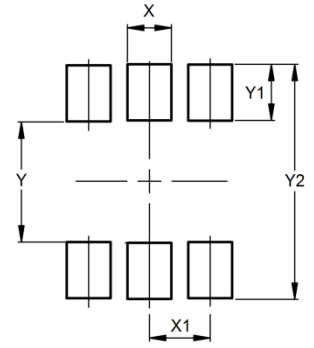
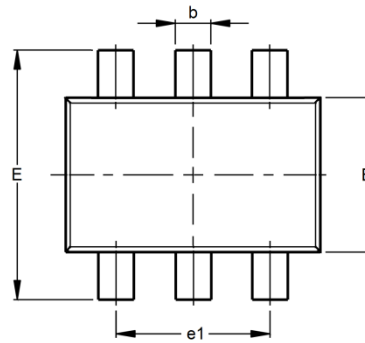
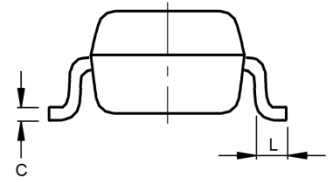
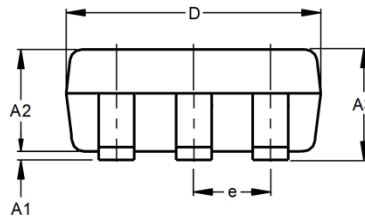

*Specifications subject to change without notice.