

# ESD Suppressor 5V 2-Unidirectional SOT-23

ME52U9V5S23

MERITEK

## FEATURE

- IEC 61000-4-2 ESD:  $\pm 15\text{KV}$  (Air)  $\pm 8\text{KV}$  (Contact)
- ESD Protection for two Unidirectional Channels
- Low Clamping Voltage
- Low Capacitance

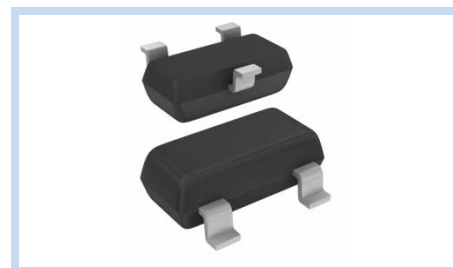

## APPLICATION

- Industrial Controls
- Set-Top Box
- Servers, Notebooks and PC Desktops
- Portable Devices

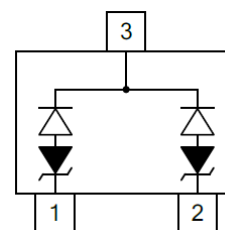

## MAXIMUM RATINGS AND CHARACTERISTICS

Parameter	Symbol	Value	Unit
ESD Voltage (Contact discharge)	$V_{ESD}$	$\pm 8$	KV
ESD Voltage (Air discharge)		$\pm 15$	
Power Dissipation	$P_D$	400	W
Operating & Storage Temperature Range	$T_J, T_{STG}$	-55~+150	$^{\circ}\text{C}$

## ELECTRICAL CHARACTERISTICS

Parameter	Condition	Symbol	Min.	Typ.	Max.	Unit
Reverse Stand-Off Voltage	--	$V_{RWM}$	--	--	5.00	V
Reverse Breakdown Voltage	$I_{BR}=1\text{mA}$	$V_{BR}$	6.00	--	--	V
Reverse Leakage Current	$V_R=5.00\text{V}$	$I_R$	--	0.80	1.20	$\mu\text{A}$
Clamping Voltage	$I_{PP}=1\text{A}, t_p=8/20\mu\text{s}$	$V_C$	--	--	9.50	V
	$I_{PP}=5\text{A}, t_p=8/20\mu\text{s}$		--	--	12.00	
Peak Pulse Current	$t_p=8/20\mu\text{s}$	$I_{PP}$	--	--	17	A
Off State Junction Capacitance	Between pin 1.2 to 3 $V_{dc}=0, f=1\text{MHz}$	$C_J$	--	--	1.00	pF

Notes:

1.  $T_A=25^{\circ}\text{C}$  unless otherwise specified

# ESD Suppressor 5V 2-Unidirectional SOT-23

ME52U9V5S23

MERITEK

## CHARACTERISTIC CURVES

Typical Peak Clamping Voltage

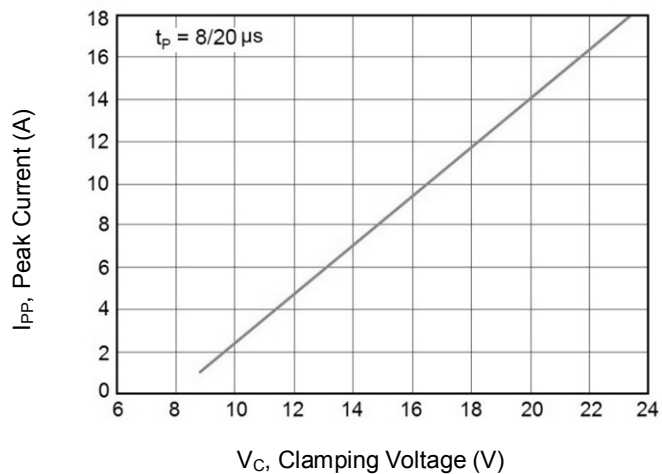

Pulse Waveform

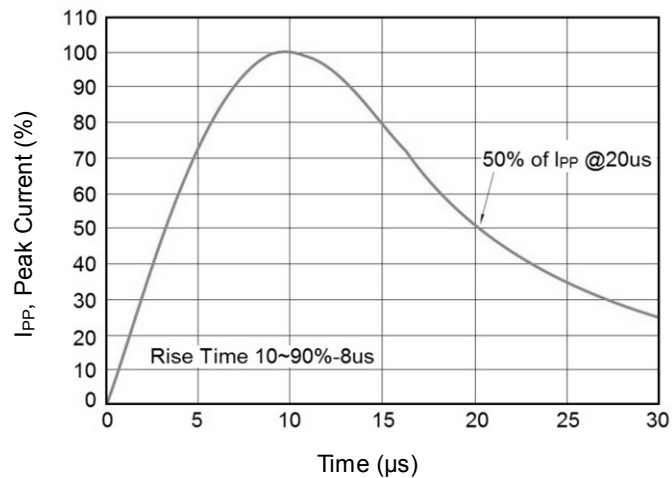

Non-Repetitive Peak Pulse Power vs. Pulse Time

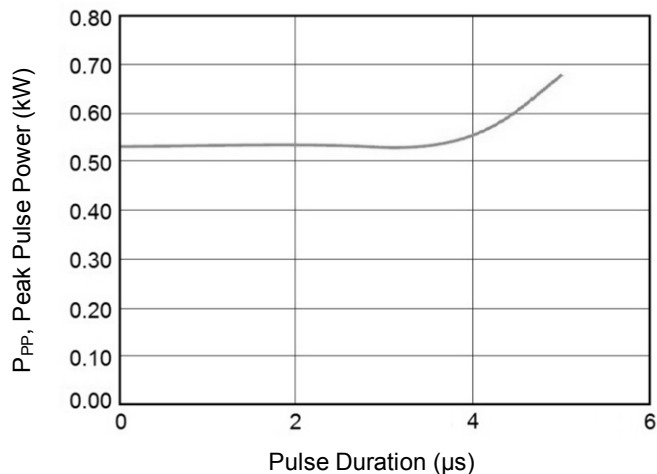

Typical Junction Capacitance Under Bias

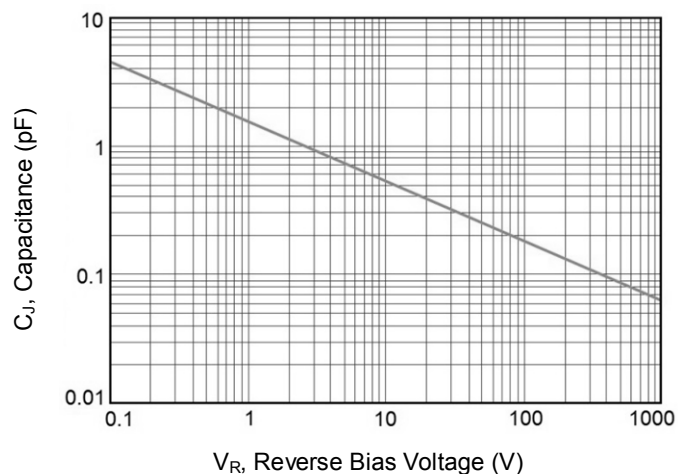

# ESD Suppressor 5V 2-Unidirectional SOT-23

ME52U9V5S23

MERITEK

## DIMENSIONS AND RECOMMENDED LAND PATTERN

Item	Min (mm)	Max (mm)
A1	0.08	0.20
A2	0.82	0.90
b	0.35	0.50
C	0.00	0.10
D	2.80	3.04
e	--	--
e1	1.80	2.00
E	2.20	2.60
E1	1.20	1.40
L	0.15	--
X	0.80	0.80
X1	1.35	1.35
Y	2.90	2.90
Y1	0.90	0.90
Y2	2.00	2.00

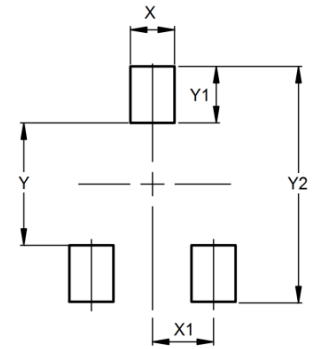
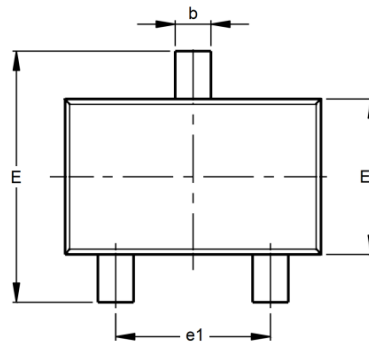
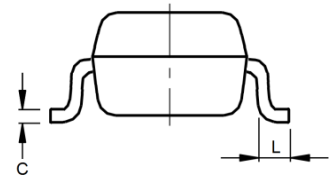
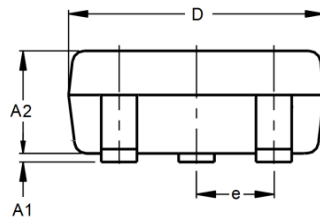

\*Specifications subject to change without notice.