

ESD Suppressor 5V Unidirectional SOT-23

ME51U9V8S23

MERITEK

FEATURE

- ESD Protection for one Unidirectional Channel
- Fast Turn On
- Low Clamping Voltage
- Space Saving Package

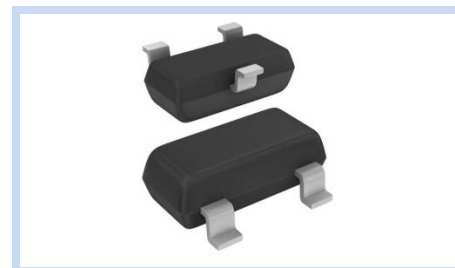

APPLICATION

- RS-232, RS-442, RS-423
- USB Port Protection
- Portable Devices
- Wireless Bus Protection

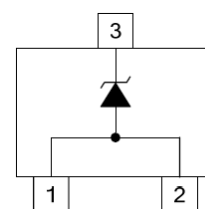

MAXIMUM RATINGS AND CHARACTERISTICS

Parameter	Symbol	Value	Unit
Peak Pulse Power (tp=8/20μs)	P _{PP}	500	W
Peak Pulse Current (tp=8/20μs)	I _{PP}	42	A
Operating & Storage Temperature Range	T _J , T _{STG}	-50~+150	°C

ELECTRICAL CHARACTERISTICS

Parameter	Condition	Symbol	Min.	Typ.	Max.	Unit
Reverse Stand-Off Voltage	--	V _{RWM}	--	--	5	V
Reverse Breakdown Voltage	I _{BR} =1mA	V _{BR}	6	--	--	V
Reverse Leakage Current	V _{RWM} =5V	I _R	--	--	20	μA
Forward Voltage	I _F =100mA, 300μs-square wave	V _F	--	--	1.5	V
Clamping Voltage	I _{PP} =42A, tp=8/20μs	V _C	--	--	9.8	V
Off State Junction Capacitance	V _{dc} =0, f=1MHz, Between I/O pins and GND	C _J	--	--	550	pF

Notes:

1. T_A= 25°C unless otherwise specified

ESD Suppressor 5V Unidirectional SOT-23

ME51U9V8S23

MERITEK

CHARACTERISTIC CURVES

Pulse Waveform

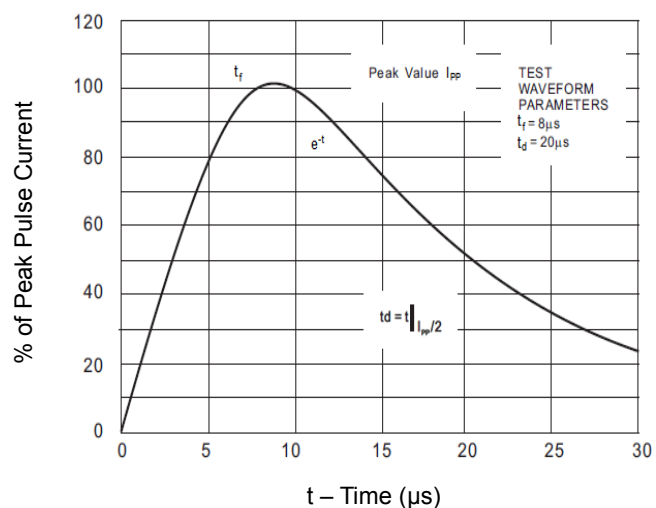

Power Derating Curve

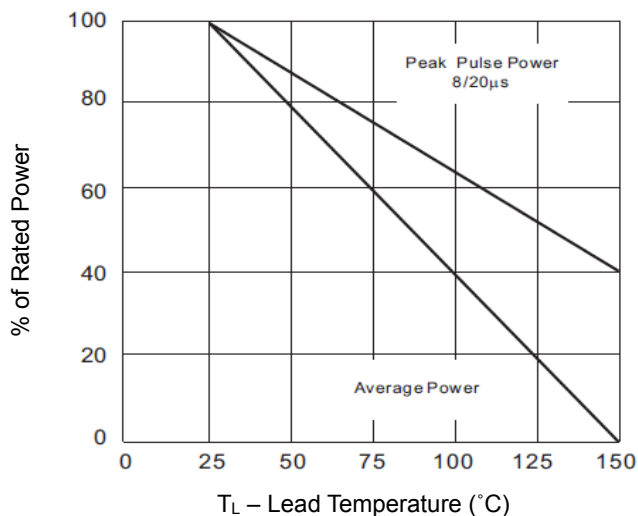

Peak Pulse Power vs. Pulse Time

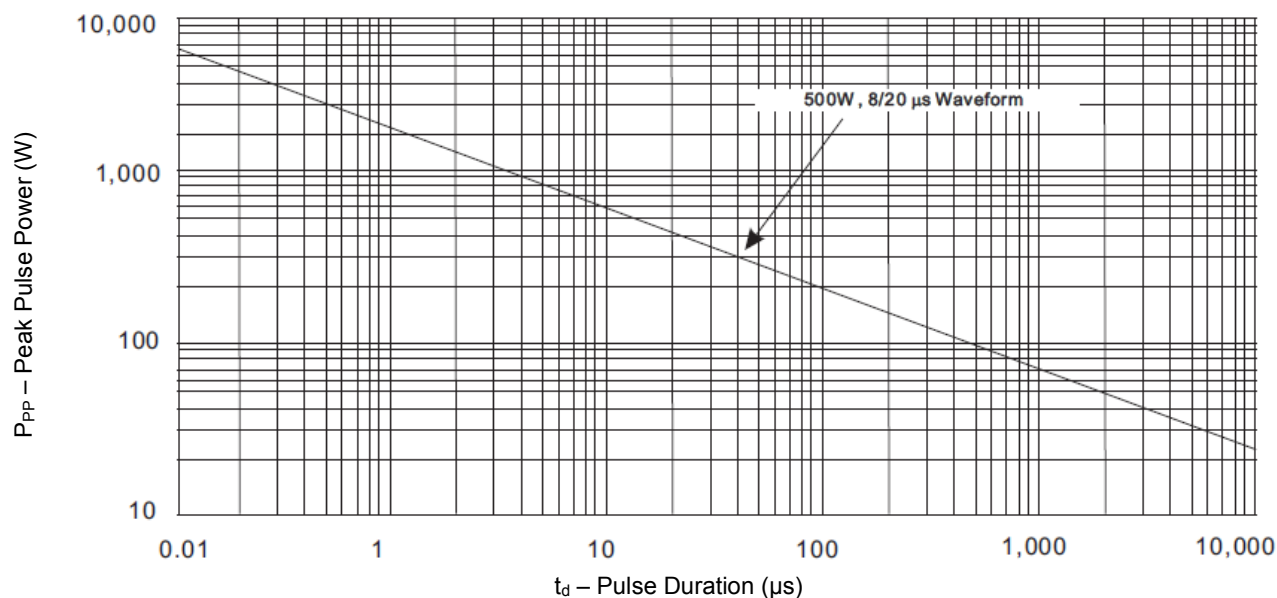

ESD Suppressor 5V Unidirectional SOT-23

ME51U9V8S23

MERITEK

DIMENSIONS AND RECOMMENDED LAND PATTERN

Item	Min (mm)	Max (mm)
A1	0.08	0.20
A2	0.82	0.90
b	0.35	0.50
C	0.00	0.10
D	2.80	3.04
e	--	--
e1	1.80	2.00
E	2.20	2.60
E1	1.20	1.40
L	0.15	--
X	0.80	0.80
X1	1.35	1.35
Y	2.90	2.90
Y1	0.90	0.90
Y2	2.00	2.00

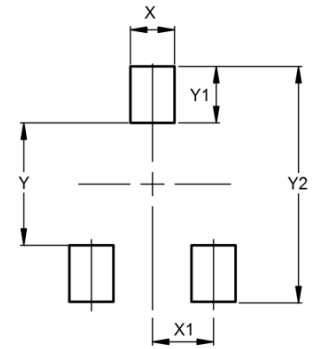
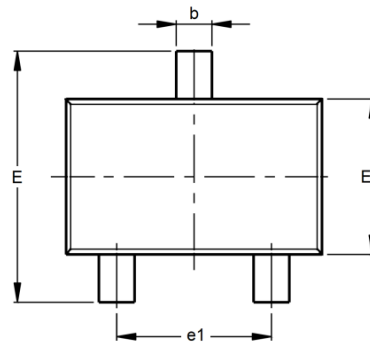
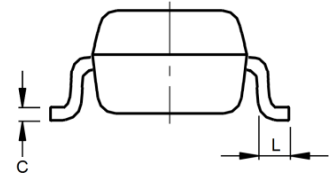
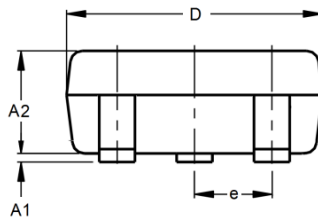

*Specifications subject to change without notice.