

# ESD Suppressor 3V 2-Unidirectional SOT-23

ME32U6V5S23

MERITEK

## FEATURE

- IEC 61000-4-2 ESD:  $\pm 30\text{KV}$  (Air)  $\pm 30\text{KV}$  (Contact)
- ESD Protection for two Unidirectional Channels
- ESD Protection for one Bidirectional Channel
- Low Clamping Voltage

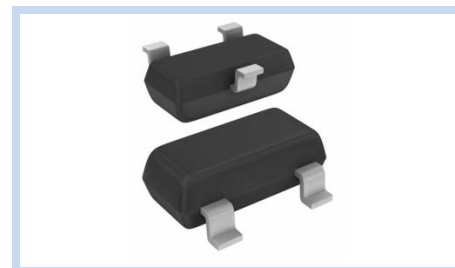

## APPLICATION

- Industrial Controls
- Set-Top Box
- Portable Devices
- Notebooks, PC Desktops and Servers

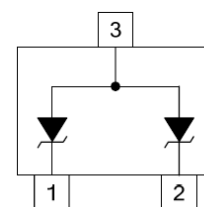

## MAXIMUM RATINGS AND CHARACTERISTICS

Parameter	Symbol	Value	Unit
ESD Voltage (Contact discharge)	$V_{ESD}$	$\pm 30$	KV
ESD Voltage (Air discharge)		$\pm 30$	
Peak Pulse Power ( $t_p=8/20\mu s$ )	$P_{PP}$	500	W
Peak Pulse Current ( $t_p=8/20\mu s$ )	$I_{PP}$	43	A
Operating & Storage Temperature Range	$T_J, T_{STG}$	-50~+150	$^{\circ}\text{C}$

## ELECTRICAL CHARACTERISTICS

Parameter	Condition	Symbol	Min.	Typ.	Max.	Unit
Reverse Stand-Off Voltage	--	$V_{RWM}$	--	--	3	V
Reverse Breakdown Voltage	$I_{BR}=1\text{mA}$	$V_{BR}$	4	--	--	V
Reverse Leakage Current	$V_{RWM}=3\text{V}$	$I_R$	--	--	125	$\mu\text{A}$
Forward Voltage	$I_F=100\text{mA}$ , 300 $\mu\text{s}$ -square wave	$V_F$	--	--	1.5	V
Clamping Voltage	$I_{PP}=43\text{A}$ , $t_p=8/20\mu s$	$V_C$	--	--	6.5	V
Off State Junction Capacitance	$V_{dc}=0$ , $f=1\text{MHz}$ , Between I/O pins and GND	$C_J$	--	--	500	pF

Notes:

1.  $T_A=25^{\circ}\text{C}$  unless otherwise specified

# ESD Suppressor 3V 2-Unidirectional SOT-23

ME32U6V5S23

MERITEK

## CHARACTERISTIC CURVES

Pulse Waveform

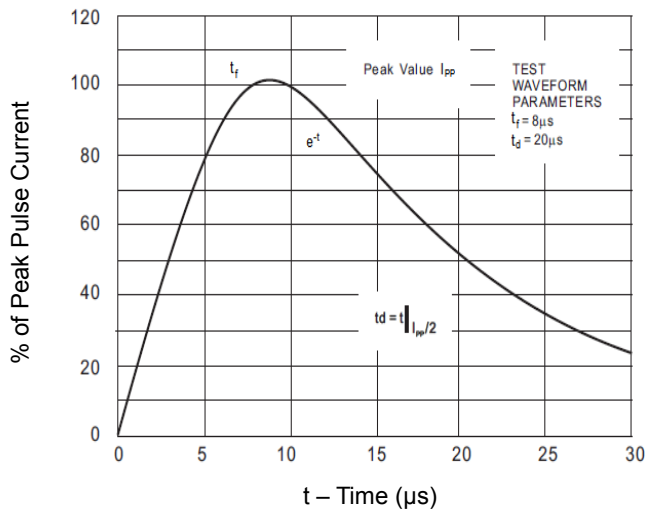

Power Derating Curve

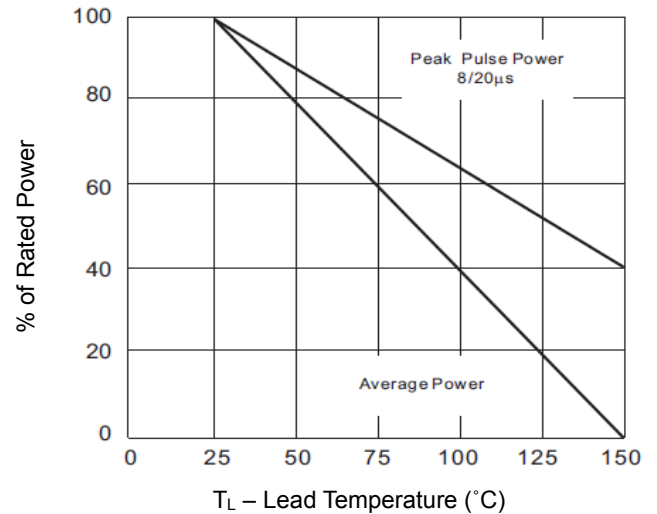

Peak Pulse Power vs. Pulse Time

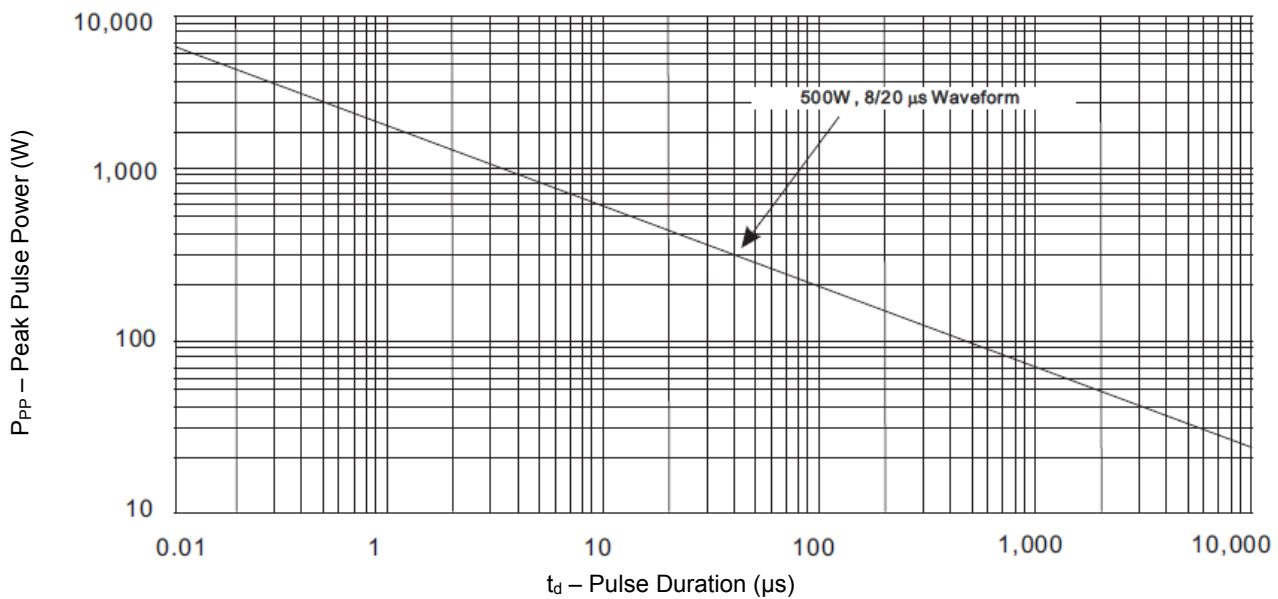

# ESD Suppressor 3V 2-Unidirectional SOT-23

ME32U6V5S23

MERITEK

## DIMENSIONS AND RECOMMENDED LAND PATTERN

Item	Min (mm)	Max (mm)
A1	0.08	0.20
A2	0.82	0.90
b	0.35	0.50
C	0.00	0.10
D	2.80	3.04
e	--	--
e1	1.80	2.00
E	2.20	2.60
E1	1.20	1.40
L	0.15	--
X	0.80	0.80
X1	1.35	1.35
Y	2.90	2.90
Y1	0.90	0.90
Y2	2.00	2.00

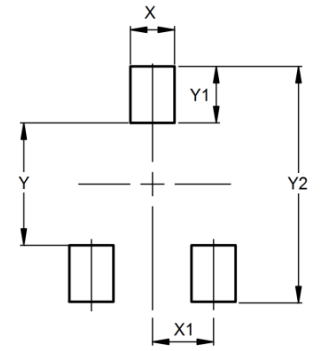
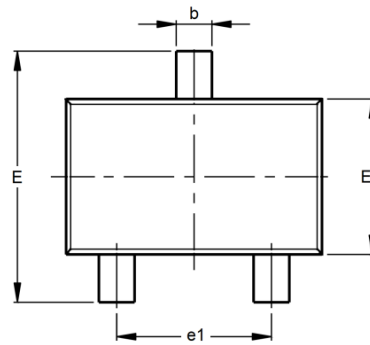
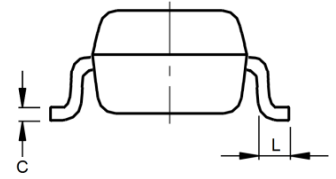
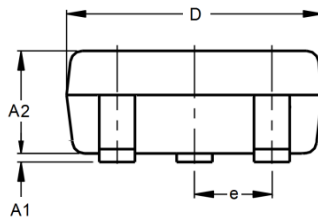

\*Specifications subject to change without notice.