

ESD Suppressor 24V 2-Unidirectional SOT-23

ME242U48S23

MERITEK

FEATURE

- IEC 61000-4-2 ESD: $\pm 15\text{KV}$ (Air) $\pm 8\text{KV}$ (Contact)
- ESD Protection for two Unidirectional Channels
- Ultra Low Capacitance: 0.8pF Typical
- Low Clamping Voltage
- Solid-State Silicon-Avalanche Technology

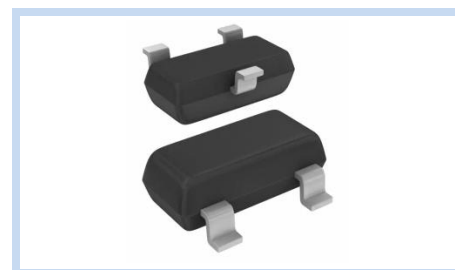

APPLICATION

- HDMI Interface Protection
- Display Port Interface
- Antenna Applications
- USB 2.0
- GaAs Photodetector Protection

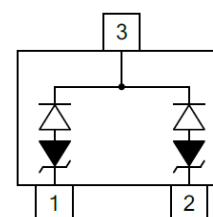

MAXIMUM RATINGS AND CHARACTERISTICS

Parameter	Symbol	Value	Unit
ESD Voltage (Contact discharge)	V_{ESD}	± 8	KV
ESD Voltage (Air discharge)		± 15	
Peak Pulse Power ($t_p=8/20\mu s$)	P_{PP}	400	W
Operating & Storage Temperature Range	T_J, T_{STG}	-55~+150	$^{\circ}\text{C}$

ELECTRICAL CHARACTERISTICS

Parameter	Condition	Symbol	Min.	Typ.	Max.	Unit
Reverse Stand-Off Voltage	--	V_{RWM}	--	--	24	V
Reverse Breakdown Voltage	$I_{BR}=1\text{mA}$	V_{BR}	26.7	--	--	V
Reverse Leakage Current	$V_R=24\text{V}$, Each I/O pin	I_R	--	--	1	μA
Clamping Voltage	$I_{PP}=1\text{A}$, $t_p=8/20\mu s$	V_C	--	--	48	V
Off State Junction Capacitance	$V_{dc}=0$, $f=1\text{MHz}$, Between I/O pins and GND	C_J	--	0.8	--	pF

Notes:

1. $T_A=25^{\circ}\text{C}$ unless otherwise specified

ESD Suppressor 24V 2-Unidirectional SOT-23

ME242U48S23

MERITEK

CHARACTERISTIC CURVES

Power Derating Curve

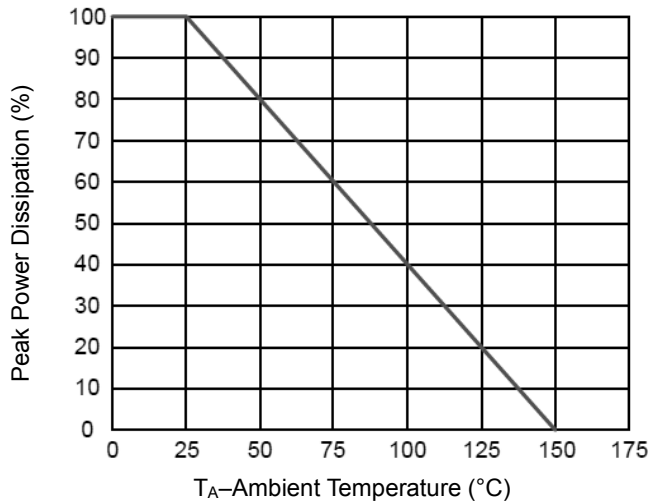

Pulse Waveforms

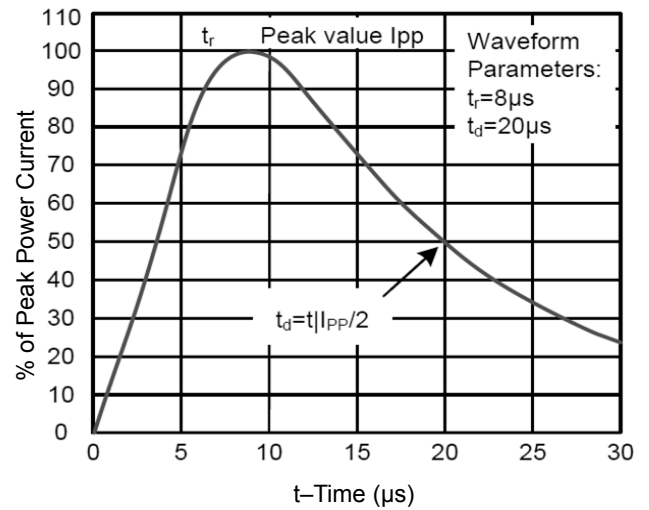

Non-Repetitive Peak Pulse vs. Pulse Time

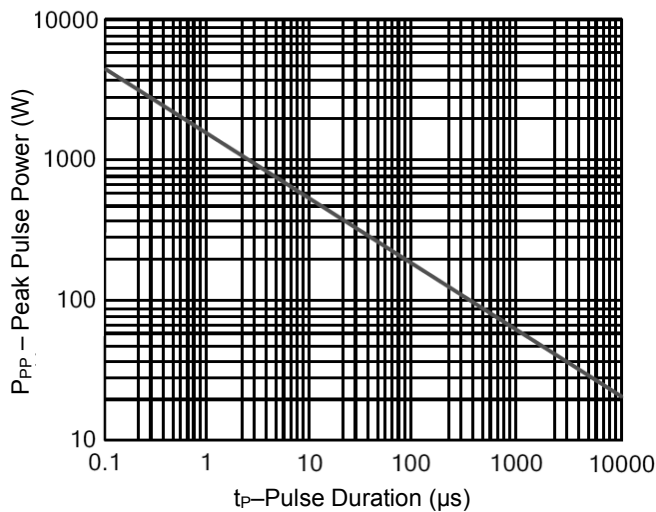

Forward Voltage vs. Forward Current

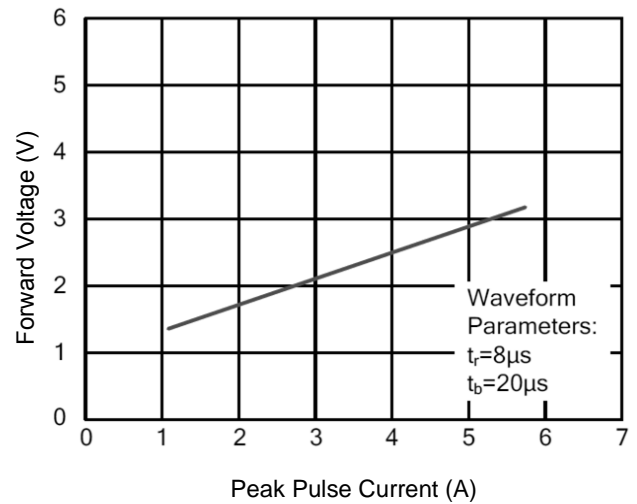

ESD Suppressor 24V 2-Unidirectional SOT-23

ME242U48S23

MERITEK

DIMENSIONS AND RECOMMENDED LAND PATTERN

Item	Min (mm)	Max (mm)
A1	0.08	0.18
A2	0.81	0.91
b	0.35	0.50
C	--	0.13
D	2.80	3.05
e	0.95	0.95
e1	1.90	1.90
E	2.10	2.49
E1	1.19	1.40
L	0.15	--
X	0.80	0.80
X1	1.35	1.35
Y	2.00	2.00
Y1	0.90	0.90
Y2	2.90	2.90

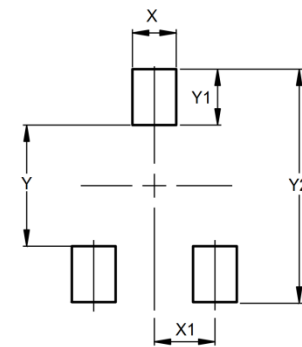
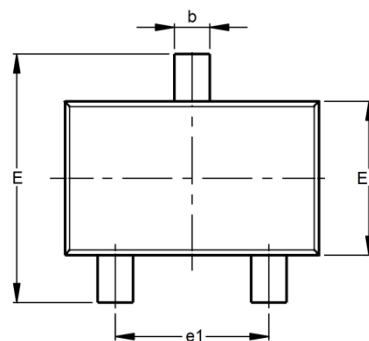
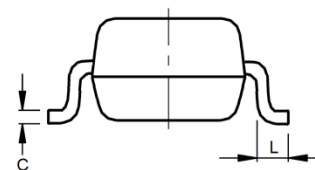
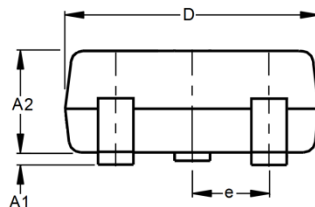

*Specifications subject to change without notice.