

ESD Suppressor 12V 2-Unidirectional SOT-23

ME122U19S231P

MERITEK

FEATURE

- IEC 61000-4-2 ESD: $\pm 15\text{KV}$ (Air) $\pm 8\text{KV}$ (Contact)
- ESD Protection for two Unidirectional Channels
- Low Clamping Voltage
- Low Capacitance

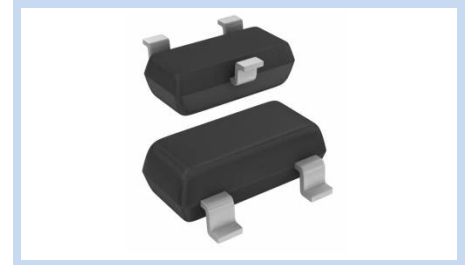

APPLICATION

- Industrial Controls
- Set-Top Box
- Servers, Notebooks and PC Desktops
- Portable Devices

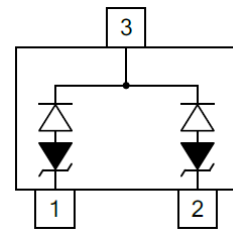

MAXIMUM RATINGS AND CHARACTERISTICS

Parameter	Symbol	Value	Unit
ESD Voltage (Contact discharge)	V_{ESD}	± 8	kV
ESD Voltage (Air discharge)		± 15	
Power Dissipation	P_D	400	W
Operating Temperature Range	T_J	-55~+125	$^{\circ}\text{C}$
Storage Temperature Range	T_{STG}	-55~+150	$^{\circ}\text{C}$

ELECTRICAL CHARACTERISTICS

Parameter	Condition	Symbol	Min.	Typ.	Max.	Unit
Reverse Stand-Off Voltage	--	V_{RWM}	--	--	12.00	V
Reverse Breakdown Voltage	$I_{BR}=1\text{mA}$	V_{BR}	13.30	--	--	V
Reverse Leakage Current	$V_R=12.00\text{V}$	I_R	--	--	1.00	μA
Clamping Voltage	$I_{PP}=1\text{A}$, $t_p=8/20\mu\text{s}$	V_C	--	--	19.00	V
Clamping Voltage	$I_{PP}=5\text{A}$, $t_p=8/20\mu\text{s}$	V_C	--	--	24.00	V
Off State Junction Capacitance	Between pin 1.2 to 3 $V_{dc}=0$, $f=1\text{MHz}$	C_J	--	--	1.00	pF

Notes:

1. $T_A=25^{\circ}\text{C}$ unless otherwise specified

CHARACTERISTIC CURVES

Typical Peak Clamping Voltage

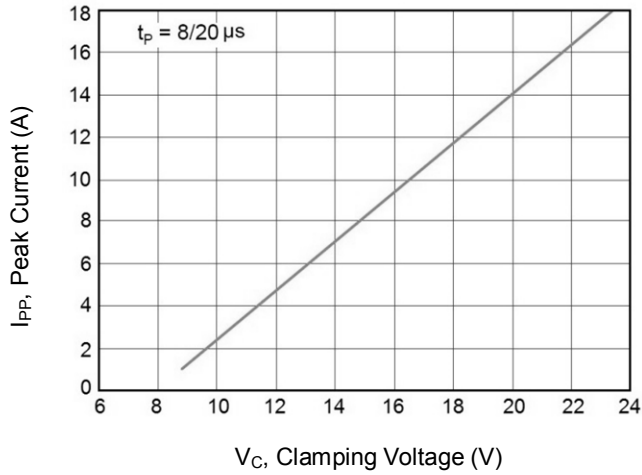

Pulse Waveform

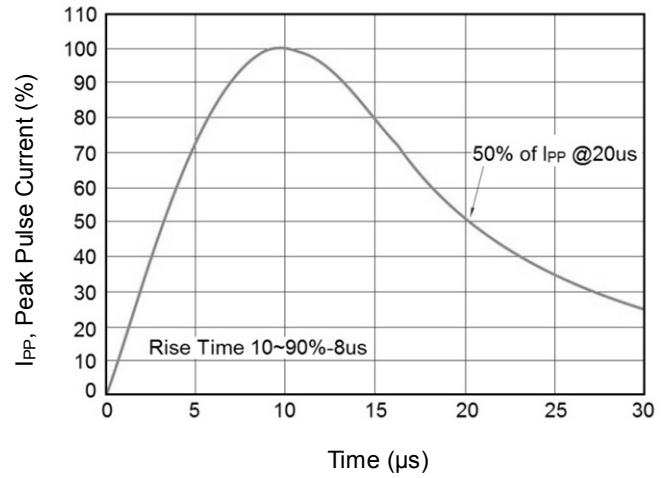

Power Derating Curve

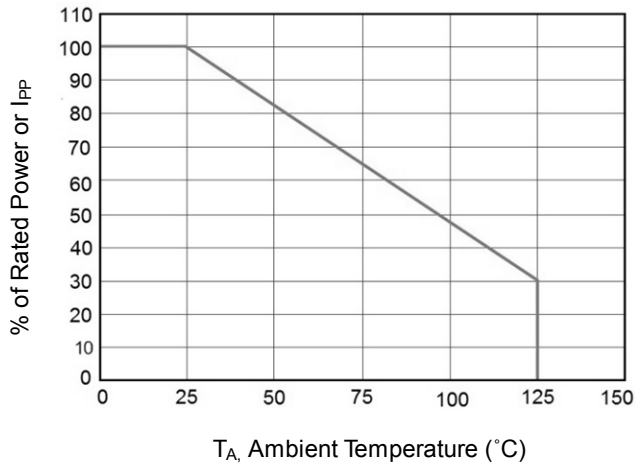

Non-Repetitive Peak Pulse Power vs Pulse Time

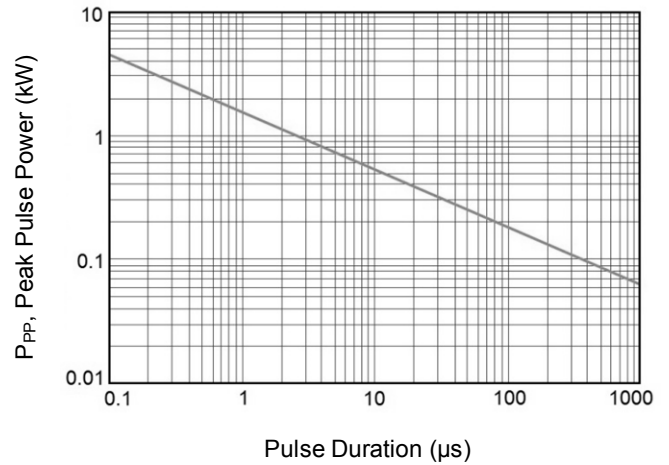

ESD Suppressor 12V 2-Unidirectional SOT-23

ME122U19S231P

MERITEK

DIMENSIONS AND RECOMMENDED LAND PATTERN

Item	Min (mm)	Max (mm)
A1	0.08	0.20
A2	0.82	0.90
b	0.35	0.50
C	0.00	0.10
D	2.80	3.04
e	--	--
e1	1.80	2.00
E	2.20	2.60
E1	1.20	1.40
L	0.15	--
X	0.80	0.80
X1	1.35	1.35
Y	2.90	2.90
Y1	0.90	0.90
Y2	2.00	2.00

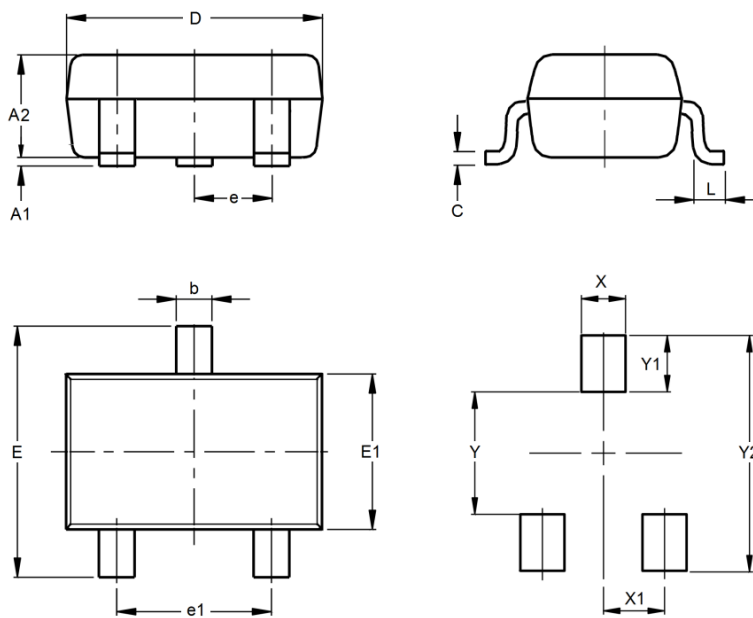

*Specifications subject to change without notice.