

Single-Phase Bridge Rectifier 4.0A KBU Package

KBU4 Series

MERITEK

FEATURE

- Operating Temperature: -55 ~ +150°C
- Average Forward Rectified Output Current 4.0A
- Repetitive Reverse Voltage from 50~1000V
- Surge Overload Ratings to 200A
- Flammability Classification 94V-0
- UL Safety Approved: Certification No: E223027

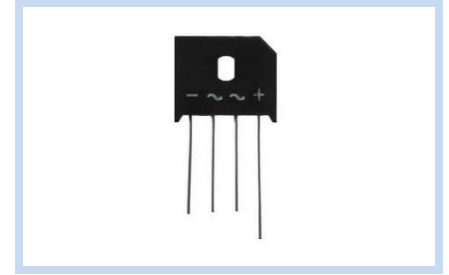

MAXIMUM RATINGS AND THERMAL CHARACTERISTICS



Parameter	Code	KBU 4A	KBU 4B	KBU 4D	KBU 4G	KBU 4J	KBU 4K	KBU 4M	Unit
Maximum Repetitive Peak Reverse Voltage	V_{RRM}	50	100	200	400	600	800	1000	V
Maximum RMS Bridge Input Voltage	V_{RMS}	35	70	140	280	420	560	700	V
Maximum DC Blocking Voltage	V_{DC}	50	100	200	400	600	800	1000	V
Maximum Average Forward Rectified Output Current	I_F	4.0, $T_A=100^\circ\text{C}$							A
Peak Forward Surge Current Single Sine-Wave Superimposed on Rated Load (JEDEC Method)	I_{FSM}	200							A
Rating for Fusing ($t < 8.3\text{ms}$)	I^2t	300							A^2sec
Maximum Instantaneous Forward Voltage Drop per Diode	V_F	1.1, $I_F=4.0\text{A}$							V
Maximum DC Reverse Current at Rated DC Blocking Voltage per Element	I_R	10, $T_A=25^\circ\text{C}$							μA
	I_R	500, $T_A=125^\circ\text{C}$							μA
Operating Junction and Storage Temperature	T_J, T_{STG}	-55~150							$^\circ\text{C}$
Typical Thermal Resistance per Element	$R_{\theta JA}$	2.7							$^\circ\text{C/W}$

Note:

1. Rating at 25°C ambient temperature unless otherwise specified. Resistive or Inductive load, 60Hz. For Capacitive load derate current by 20%.
2. Thermal resistance from Junction to Ambient on P.C. board mounting.

DIMENSION AND PIN CONFIGURATION

Item	Min. (mm)	Max. (mm)	Item	Min. (mm)	Max. (mm)
A	22.70	23.70	H	25.40	-
B	16.80	17.80	I	1.70	2.20
C	-	19.30	K	4.60	5.60
D	4.20	4.60	L	5.10	6.10
E	3.60	4.10	M	6.60	7.00
F	1.90 R. TYP. (2 PLACES)		N	4.70	5.10
G	10.30	11.30	O	1.20	1.30

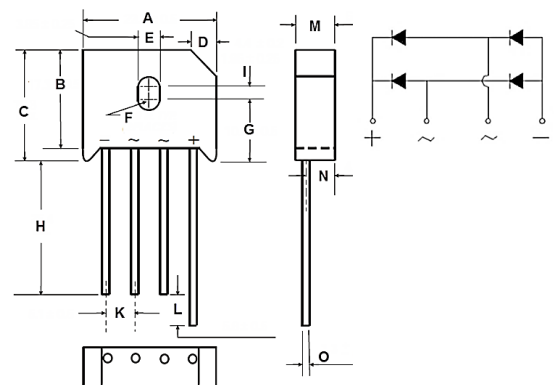

Single-Phase Bridge Rectifier 4.0A KBU Package

KBU4 Series

MERITEK

RATING AND CHARACTERISTIC CURVES

Derating Curve for Output Rectified Current

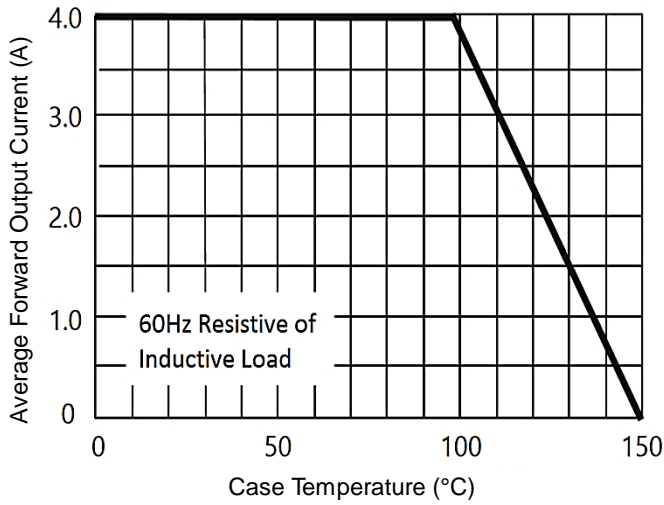

Maximum Non-Repetitive Peak Forward Surge Current

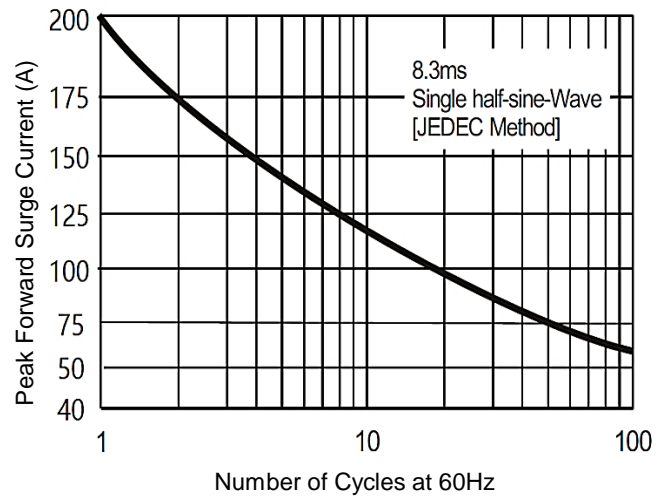

Typical Instantaneous Forward Characteristics

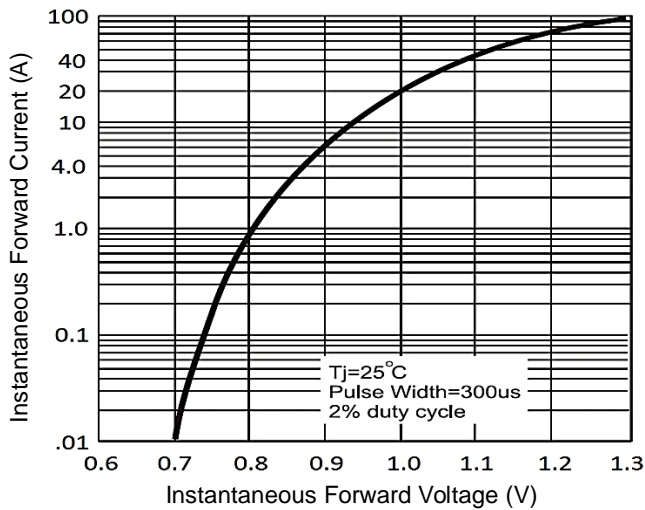

Typical Reverse Characteristics at $T_j = 25^\circ\text{C}$

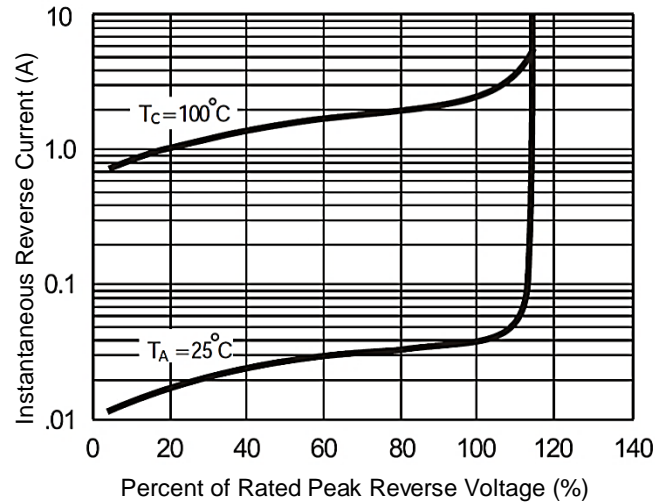

Typical Junction Capacitance

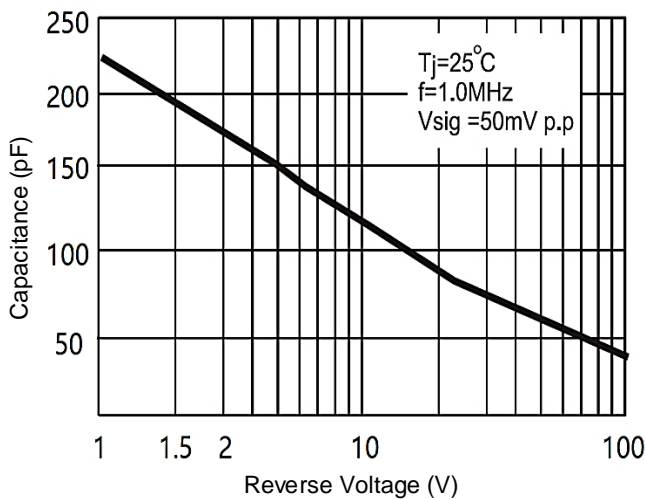

*Specifications subject to change without notice.

Single-Phase Bridge Rectifier 4.0A KBU Package

KBU4 Series	MERITEK
-------------	---------